

basic audio

by **NORMAN H. CROWHURST**

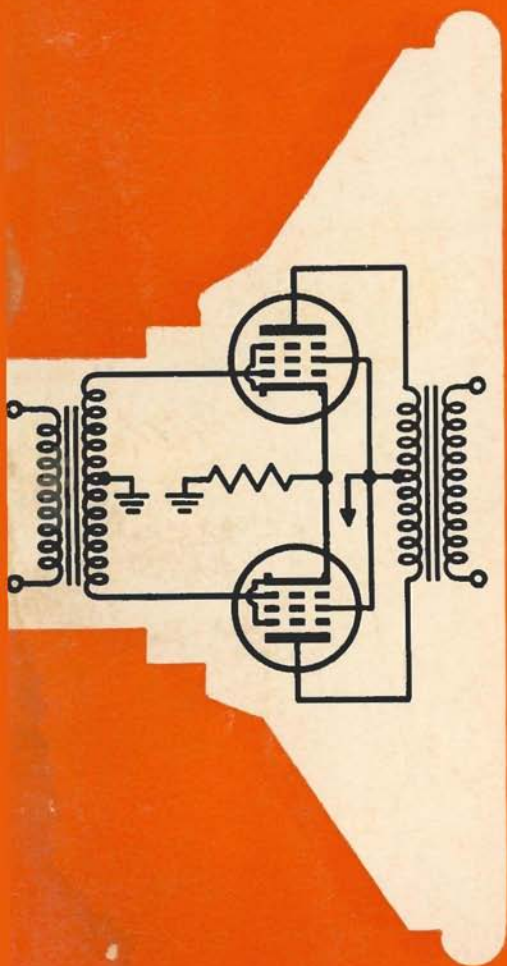

VOL. 1

THE NATURE OF SOUND

ACOUSTICS

MICROPHONES

LOUDSPEAKERS

BAFFLES & HORNS

OTHER TYPES OF SPEAKERS

IMPEDANCE MATCHING

DIVIDING NETWORKS & CROSSOVERS

RESONANCE

a RIDER publication

basic audio

by NORMAN H. CROWHURST

VOL. 1

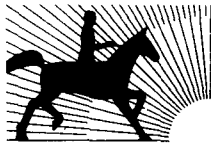

JOHN F. RIDER PUBLISHER, INC.
116 West 14th Street • New York 11, N. Y.

Copyright August 1959 by John F. Rider Publisher, Inc.

All rights reserved. This book or any parts thereof may not be reproduced in any form or in any language without permission of the publisher.

Library of Congress Catalog Card Number 58-13425

Printed in the United States of America

PREFACE

Audio is like Topsy: it wasn't born, it just grew. Whatever Topsy may have been like, Audio has grown like a gawky child—not always in proportion! Originally associated with radio and later with high fidelity, audio now finds application in many other places—to name a few: computers, automation, ballistics and guidance for missiles, sonar detection for navigation, ultra- and infra-sonics for medicine, both diagnostic and therapeutic, as well as geophysical and other work. In fact Audio is now one of the largest and most basic divisions of electronics.

Courses in audio were nonexistent not too many years ago. Since then, textbooks and courses have appeared. But their approach follows the principle of many professors: "I learned it the hard way—you'll have to!" It's like learning watchmaking from a bridge-building man.

My wide experience in various aspects of audio has shown the need for a better way. In industry, in academic education, and particularly in working with graduates from college, this need is evident. My extensive technical writing for magazines and consultant work in the industry have also shown me audio's educational needs.

Many competent "practical men" find themselves hindered by lack of academic background in the subject. They can do their job in their own established "groove." But they do not have—and find it impossible to acquire—the background to enable them to expand outside this groove. These people need help in closing the gap between "theory" and "practice."

Engineers are conversant with the accepted "technical language," but they read the literature with only an "intuitive comprehension" (or should it be apprehension?). Their education dragged them past many "awkward spots" about which they have never felt really "comfortable." Like the King of Siam in "The King and I," they find many facts of which they wish they were more certain they are sure.

Very important are the new students, technicians, and audiophiles. They will need a basic education in audio to enable them to add their contribution to progress (and to earn themselves a living!). Why make it difficult? They'll do much better if they can get a good start.

All-in-all, it is time that certain roundabout approaches to this key subject were eliminated. We need a direct, meaningful way to take the place of the difficult detours. Then each of our three groups can not only "learn audio," but also understand it! This three-volume book results from the author's extensive education research. The finished arrangement achieves a completely new directness.

Let me give just one example: how many understand the behavior of a coupling capacitor, particularly its contribution to amplifier transient performance, and what sometimes happens to feedback? This has always been based on the concept of capacitive reactance, which does not adequately *explain* all the effects. We have adopted a practical "what happens?" approach.

As a result, someone who learned this the old way may miss the familiar landmark of the reactance concept—when he expects it; a closer examination will reveal the reason for postponing it: the whole presentation has been arranged to avoid the "dead spots" left by the traditional approach.

Inevitably such a change of approach will mean a change of stress. I make no apology for this. I know from practice that it is far more successful in getting Basic Audio "across."

It would be impossible to acknowledge the very many who have, knowingly or unknowingly, contributed to my experience, making this book possible. But I would like to express my thanks to the John F. Rider staff for their cooperation in "packaging" it in a form that interprets my intentions so well.

NORMAN H. CROWHURST

New York, N.Y.
August 1959

CONTENTS

VOL. I—BASIC AUDIO

Introduction	1
The Nature of Sound	2
Questions and Problems	25
Acoustics	26
Questions and Problems	46
Microphones	47
Questions and Problems	62
Loudspeakers	63
Baffles	68
Horns	72
Other Types of Speakers	82
Questions and Problems	86
Impedance Matching	87
Dividing Networks and Crossovers	93
Resonance	103
Audio Response Curves	106
Questions and Problems	111
Index	114

INTRODUCTION

What Audio Is

In the early days of radio, the word "audio" was used to describe the part of a radio receiver (or transmitter) that amplifies the audio, or sound frequencies. After detecting (later called *demodulating*) the radio waves or carrier, the signal was rather feeble, hardly sufficient to be audible in the headphones, so an *audio* amplifier was used to make the feeble signal audible in comfort. A similar amplifier was needed at the transmitter to magnify the feeble microphone currents for modulation of the radio carrier.

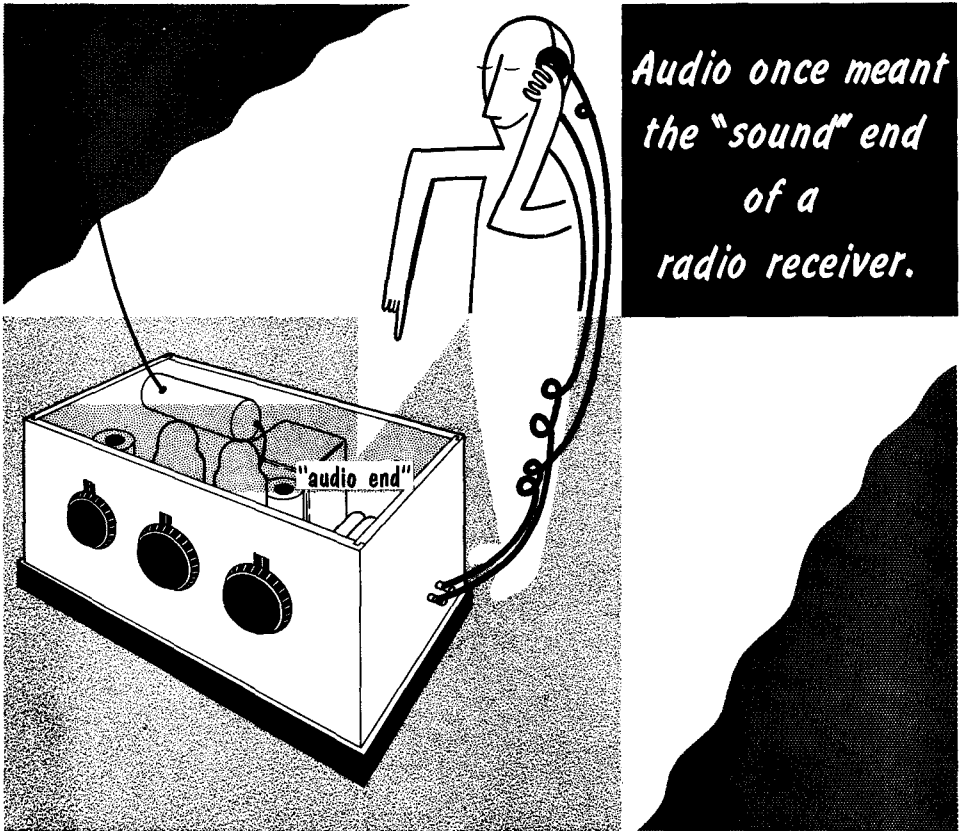

From those early beginnings, audio amplifiers have found more and more uses, and have improved in performance. Quite early, audio amplification was applied to the making and reproducing of phonograph records, giving us the first "electrical" reproduction. Since then, the methods developed have been used for many things: all kinds of control mechanisms for industry; sonar-type detection devices; vibration measuring equipment for aircraft and other types of development or research; and many of the "brain cells" used in electronic computers, to name just a few.

THE NATURE OF SOUND

What Sound Is

Air can move in different ways. One way can be illustrated by an oscillating electric fan. It blows the air at a comparatively slow speed, but moves quite a quantity of it. The slowness with which the air is moving is apparent because the draft of air reaches you a little while after the fan has stopped blowing in your direction. Here a large quantity of air is moved at a speed of only a few feet per second (much slower than sound travels). The air movement is large, and there is hardly any compression.

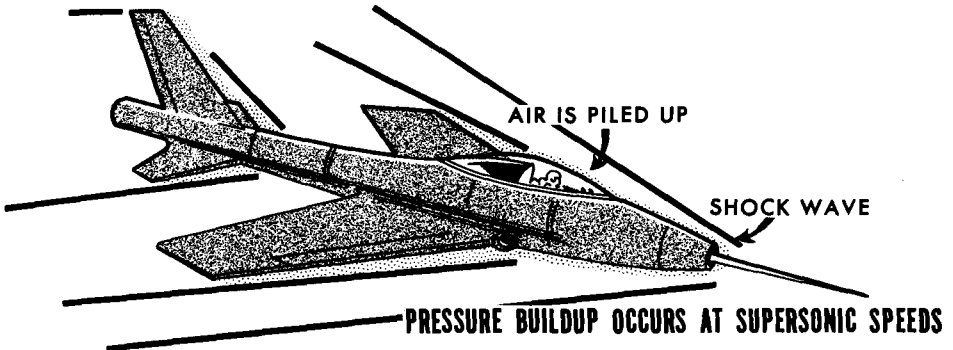
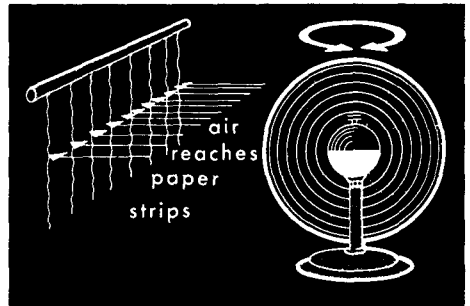
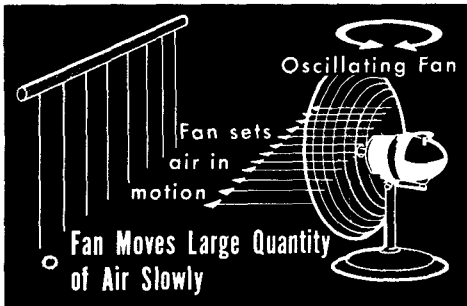

When a jet aircraft breaks through the sound barrier, however, it encounters different (and, at first, strange) kinds of air movement. The aircraft is now traveling faster than sound, and the air in front of it is no longer moving freely, but is "piled up" at high pressure on the front surfaces of the plane. As the aircraft goes through space, more air piles up in front of it, while some escapes at the side, producing the well-known "shock wave." The air in front of the plane hardly moves (relative to the aircraft), but is in a state of high compression—just the opposite condition from the air moved by the fan. However, the aircraft must move faster than sound (about 750 miles an hour) to cause this effect.

Both these forms of air movement do not "carry" very far: air movement from a fan soon gets "lost," and the pressure buildup in front of the aircraft in supersonic flight is not very deep—at most a few feet.

THE NATURE OF SOUND

Characteristics of Sound Waves

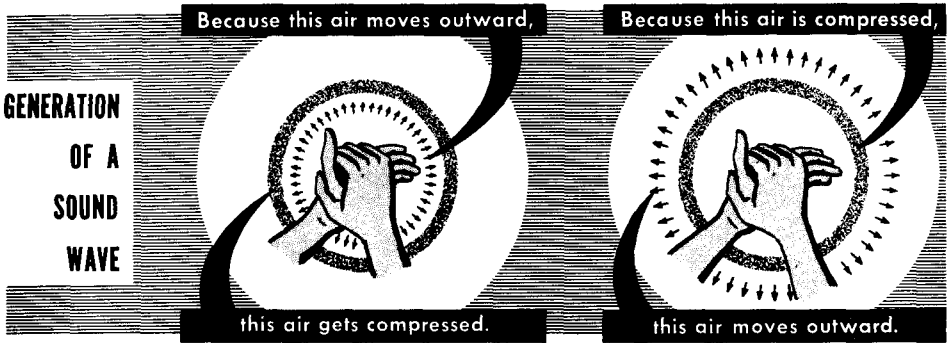

Sound waves combine these two forms of movement so as to cover great distances with only small air movements. Take the sound of a hand clap—when your hands come together, a small amount of air is forced out quite suddenly at the last instant.

The air pushed out by the hands clapping has a momentary movement *and* some pressure, although both are quite small compared to the movement produced by the fan or the pressure buildup of the supersonic jet. Two things now happen at the same time:

1. Because the pressure of the air close to the hands is momentarily greater than that further away, air moves outward.
2. Because the air close to the hands is moving outward, the air immediately beyond it also gets compressed.

The two actions combine to keep the pressure and movement wave traveling at a natural speed—the propagation velocity of sound in air. This is *not* to be confused with the speed at which individual air particles move due to the wave.

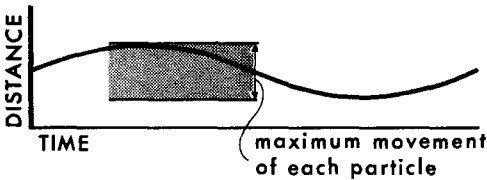

THIS shows how each air particle moves back and forth... These very small movements passed

How a SOUND WAVE TRAVELS

from one particle to the next propagate the sound

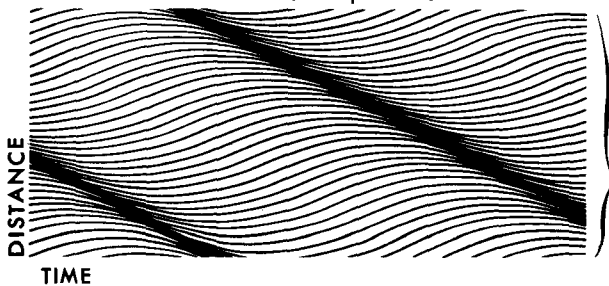

sound wave travels this far in a given time although the separate air particles only move back and forth

THE NATURE OF SOUND

Characteristics of Sound Waves (contd.)

Note that, after the wave has passed, the air stops moving. A body of air does *not* move with the wave, but the energy in the wave is passed on from particle to particle, in much the same way that (in the illustration) the impact of one penny is transmitted along a line of pennies.

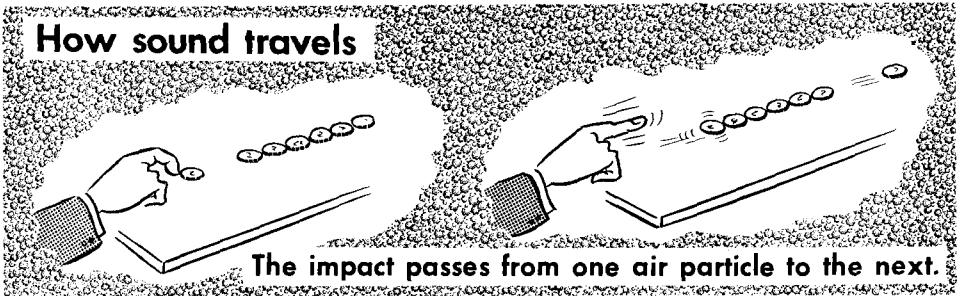

The natural speed, or propagation velocity, of sound is controlled by two properties of the air through which it travels:

1. How much squeezing more of it into a given space will increase its pressure—its compressibility (known technically as elasticity). This feature takes control of the air piled up in front of the supersonic jet.
2. How much force is needed to get a given quantity of it moving, or to stop its motion—its *density* (or mass per unit volume). This feature is responsible for carrying the draft created by the fan.

The natural speed, or propagation velocity, of sound in air is roughly 1100 feet per second, or 750 miles per hour.

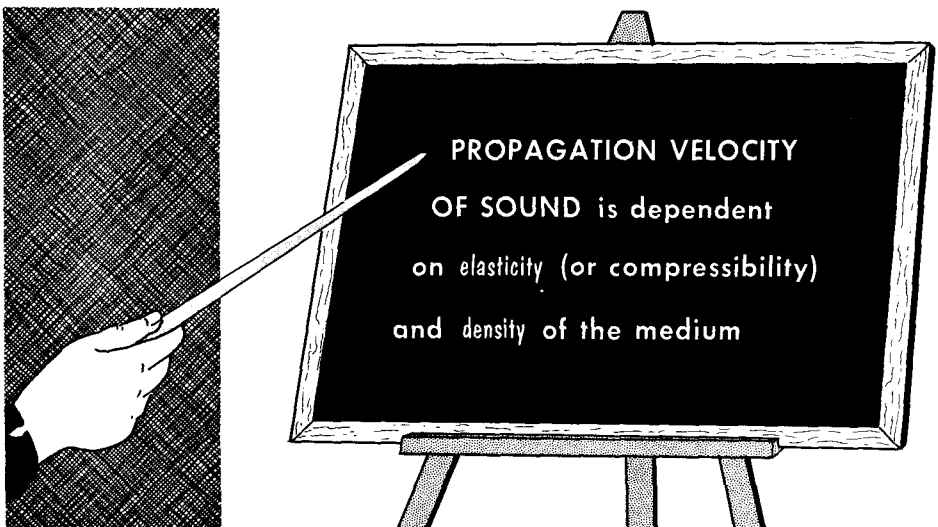

THE NATURE OF SOUND

How Fast Sound Travels

The speed, or propagation velocity, of sound depends on the elasticity of air and on its density. Although we do not normally measure these properties, we can easily find the temperature and barometric pressure of the air, which affect both its density and elasticity. What we would like to know is: "How does the speed of sound change with atmospheric pressure and temperature?"

Experiments and advanced theory provide the following answers:

1. Change in barometric pressure alters the density of air (how much of it there is in a given space) and its compressibility (the more compressed it is, the more it resists further compression). Both change together and neutralize their effect on velocity of sound, so it is not appreciably dependent on barometric pressure.
2. Change in temperature also affects both the density and compressibility of air, but not so as to neutralize as pressure does. A useful formula says that the velocity of sound in air is approximately 1086 feet per second at 0° Centigrade (the freezing point of water), and rises 2 feet per second for each Centigrade degree rise in temperature.

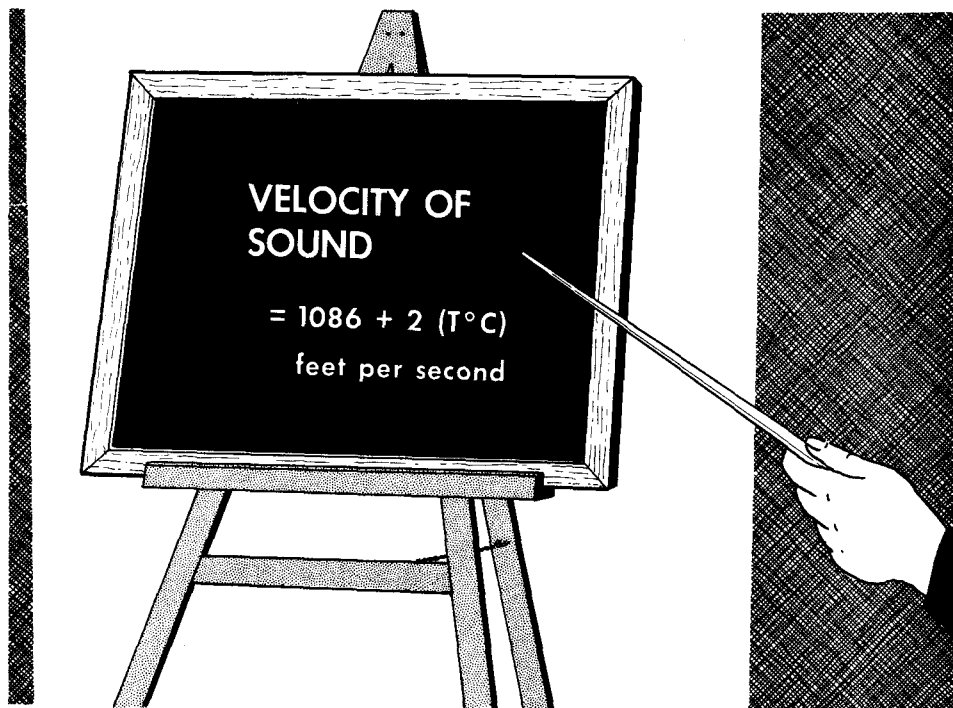

At 20° C (normal room temperature), sound travels at $1086 + (2 \times 20) = 1126$ feet per second.

THE NATURE OF SOUND

How Fast Sound Travels (contd.)

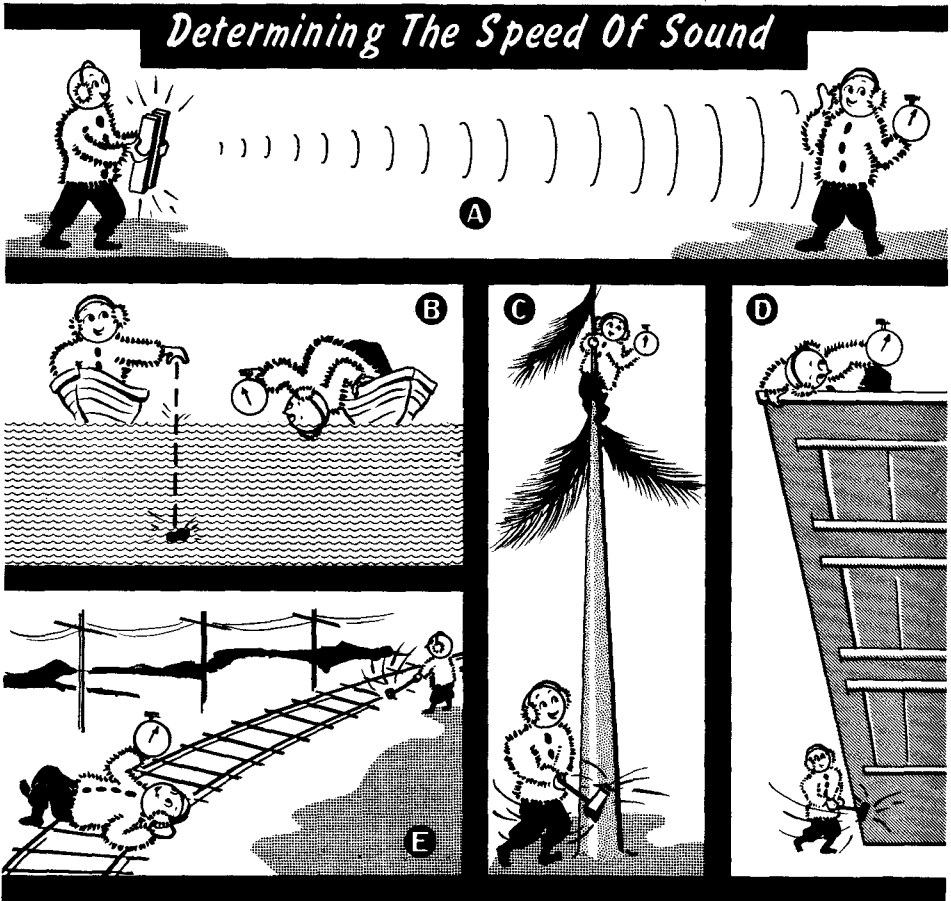

Sound also travels in almost any medium besides air, because everything (except a vacuum) possesses the two necessary properties, density and compressibility. (Even the most "incompressible" substances "give" a little.) For example, water is about 80 times more dense than air, but it also offers an even greater opposition to compression. Owing to its greater density, we should expect sound to travel more slowly in water than it does in air. Water, however, is less compressible, which tends to make sound travel faster. The combined effect makes the speed of sound in water about 4.7 times faster than in air. The following table gives the speed of sound in different substances measured at 0°C:

Air	1086 feet per second	Brick	11,980 feet per second
Water	4700 feet per second	Iron	16,000 feet per second
Pinewood	10,900 feet per second	Steel	16,360 feet per second

THE NATURE OF SOUND

Sources of Sound

Most sounds are more than a single “pulse” of sound, such as a hand-clap. For example, the reed of a harmonica or accordion vibrates at its resonant frequency and allows the air to be emitted in “bursts.” Each burst of air pressure and movement is radiated in the same way as a single hand-clap.

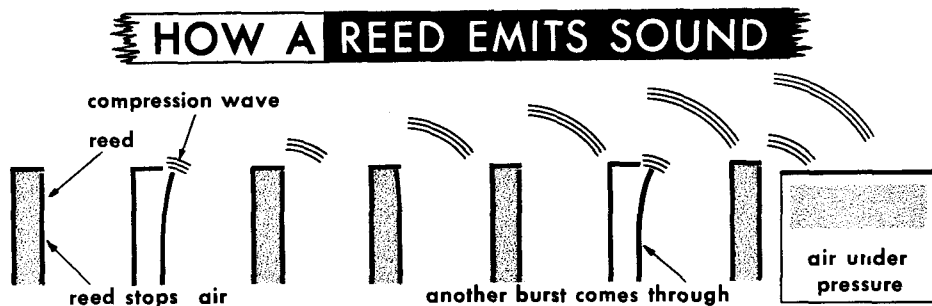

There are also other forms of vibration that produce sound: a vibrating piano string causes the sound board of the piano to vibrate. This moves the air in contact with it, producing alternate waves of compression and expansion (*rarefaction*). All stringed instruments use the same principle; in the violin, the string vibrations are transmitted to the body of the instrument, which moves the air in contact with it. In addition, there are wind instruments in which a column of air inside a tube vibrates in a manner controlled by the internal dimensions of the instrument. The contact of the air column with outside air at one end of the column or through an opening allows sound to be radiated.

All these sounds are produced by a *periodic* vibration at regular intervals (definite *frequency*). Other sounds are not rhythmic, and do not give musical tones because they are due to vibrations that are not regular or periodic—clapping, rattling, and scraping sounds, and all kinds of noises, like those that come from a factory, street, or kitchen, or even voices, except when singing.

HOW A VIOLIN EMITS SOUND

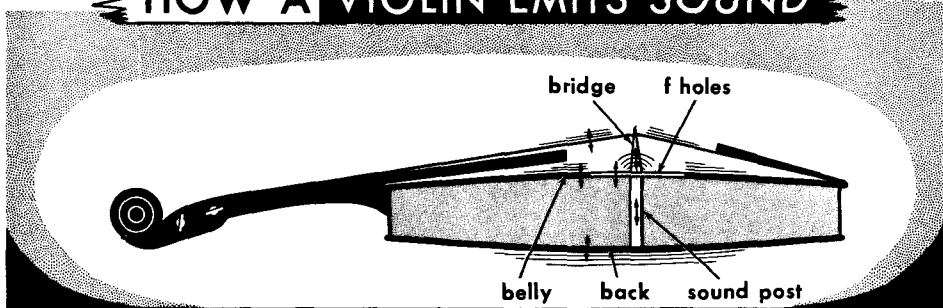

THE NATURE OF SOUND

Frequency and Pitch (contd.)

Every time frequency is *doubled*, pitch changes one *octave*. A two-octave rise in pitch quadruples the frequency; a three-octave rise in pitch multiplies it eight times. Any two adjacent notes on a piano keyboard have a constant ratio between their frequencies; since there are twelve notes per octave, this ratio is a number that, multiplied by itself twelve times, equals 2. The difference in frequency between two successive notes on the keyboard is not constant, but the *ratio* between their frequencies is constant; the frequency of the upper note is 1.059 times that of the lower one.

$$1.059 \times 1.059 \times 1.059 \times 1.059 \times 1.059 \times 1.059 \times 1.059 \times 1.059 \times 1.059 \times 1.059 \times 1.059 \times 1.059 = 2 \text{ (very nearly)}$$

In ordinary arithmetic, the difference between successive numbers is always the same—one. A system of numbers or quantities where successive items are separated by a *constant fraction*, rather than by the same amount, is called a *logarithmic system*. The relationship between frequency and pitch is logarithmic, as may be seen from the fact that to raise the pitch each octave, the frequency has to be *multiplied* by a power of two, and to raise the pitch by any desired musical interval, the frequency has to be *multiplied* by a figure corresponding to that pitch interval.

This can be shown visually by using “logarithmic” paper, where the pattern of lines is repeated for every numerical increase of ten times, and the distance covered by each change of ten times is the same. Similarly, each ratio of two is the same distance on the scale, as is any other ratio.

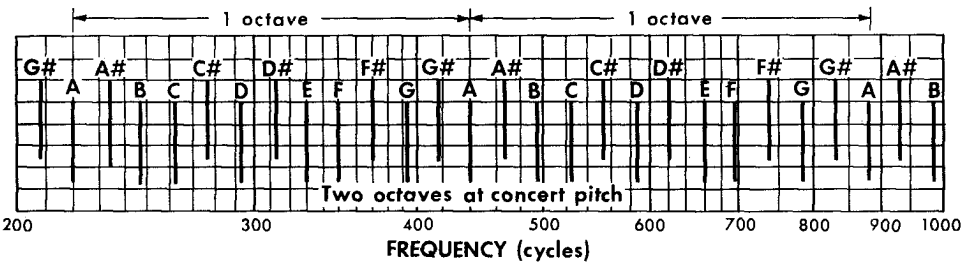
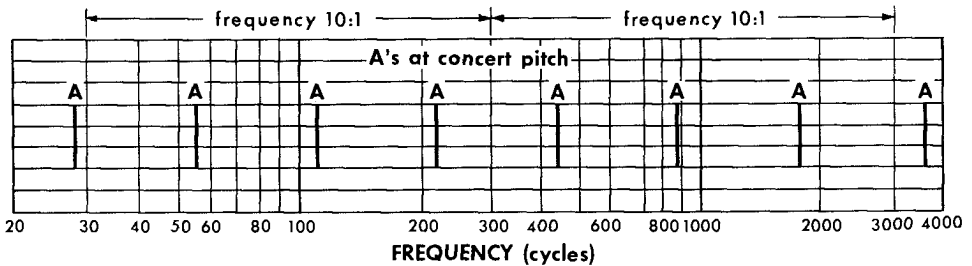

PLOTTING FREQUENCIES ON A LOGARITHMIC SCALE

THE NATURE OF SOUND

Frequency and Pitch (contd.)

Different kinds of sound, both musical and otherwise, are characterized by different ranges of frequencies :

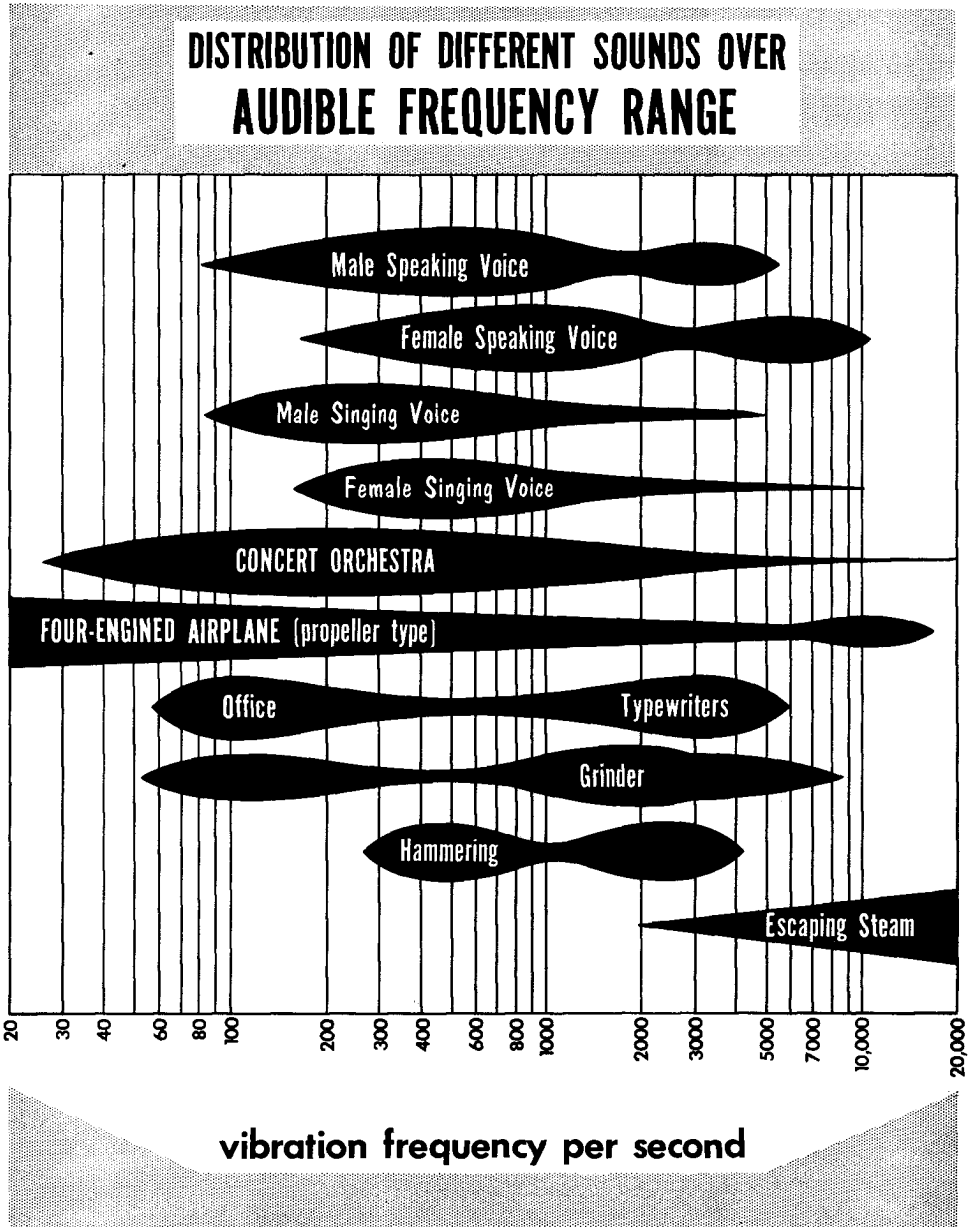

THE NATURE OF SOUND

Intensity and Loudness

As well as having different frequencies, sounds also differ in loudness. This means that the vibrations we hear are of greater or smaller intensity. The horn of an ocean liner produces such an intense vibration that you can feel it as well as hear it. A piece of paper held near the source of such a sound will vibrate hard enough to numb your fingers.

Vibrations That Can Be Felt

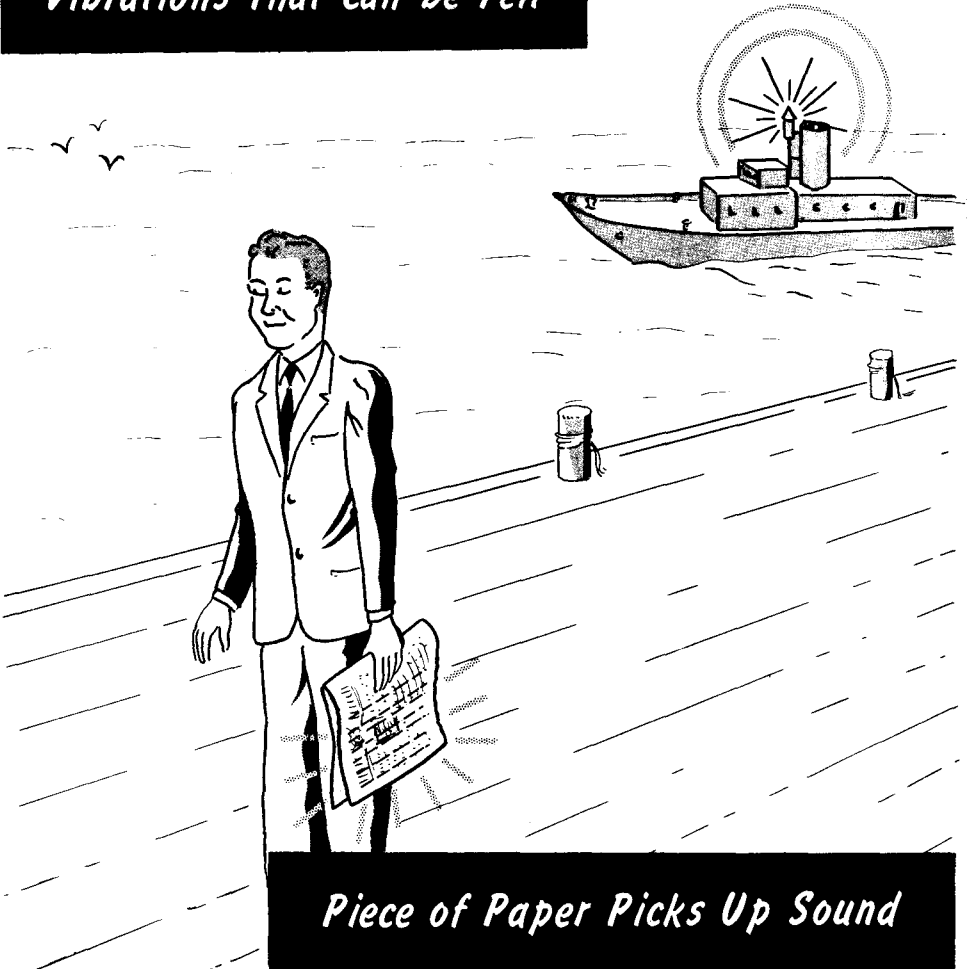

Piece of Paper Picks Up Sound

The ticking of a watch, however, is of very low intensity. Unless the surroundings are fairly "quiet" you may be unable to hear it at all. Certainly you would never hear it near the horn of an ocean liner.

THE NATURE OF SOUND

Intensity and Loudness (contd.)

Sound intensity is a measure of the *acoustical power* transmitted by the sound wave. Intensity is measured in terms of a certain section of the wave, specified as one square centimeter in scientific measurements. (There are 6.45 square centimeters in a square inch.)

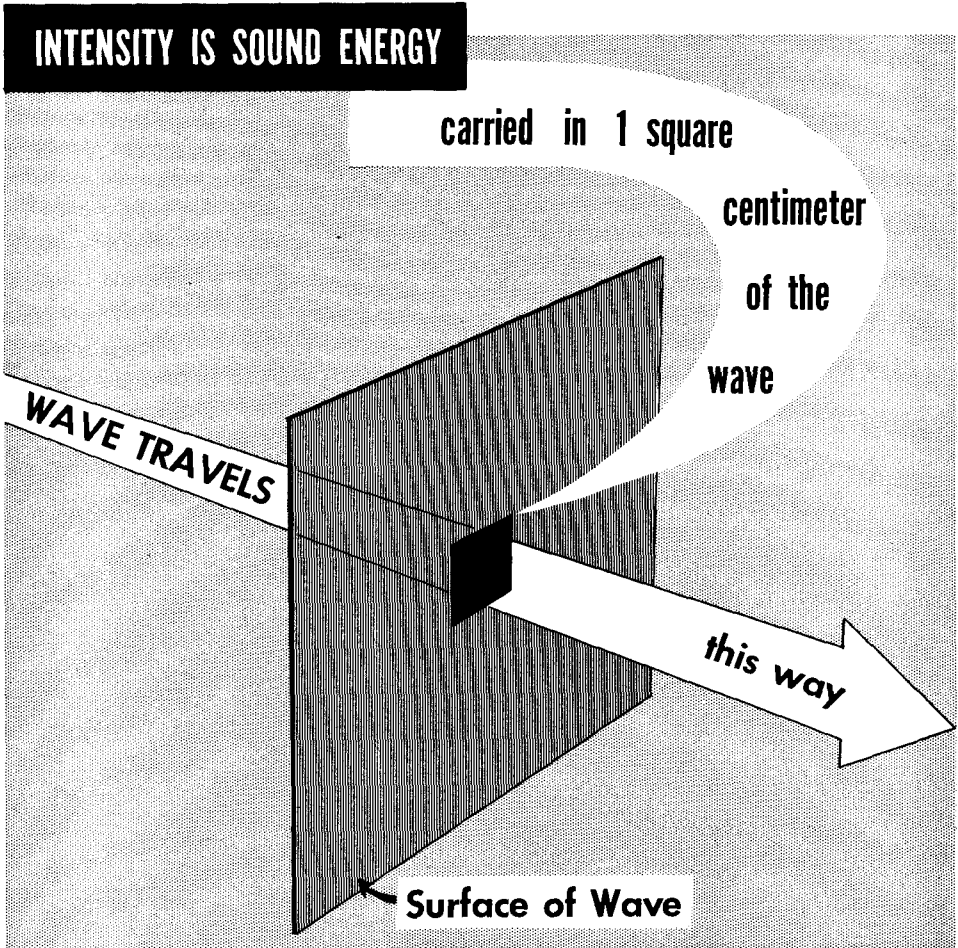

Any kind of power can be measured in watts. This is true of sound-waves. One-tenth of one quadrillionth of a watt (.000,000,000,000,001 watt) of sound power passing through an area of one square centimeter is not quite audible, using a vibration frequency of 1000 cycles per second. One-quadrillionth of a watt (.000,000,000,000,001 watt), however, is easily audible. A sound that is loud enough to be almost painful represents an intensity of less than one-thousandth of a watt per square centimeter.

THE NATURE OF SOUND

Intensity and Loudness (contd.)

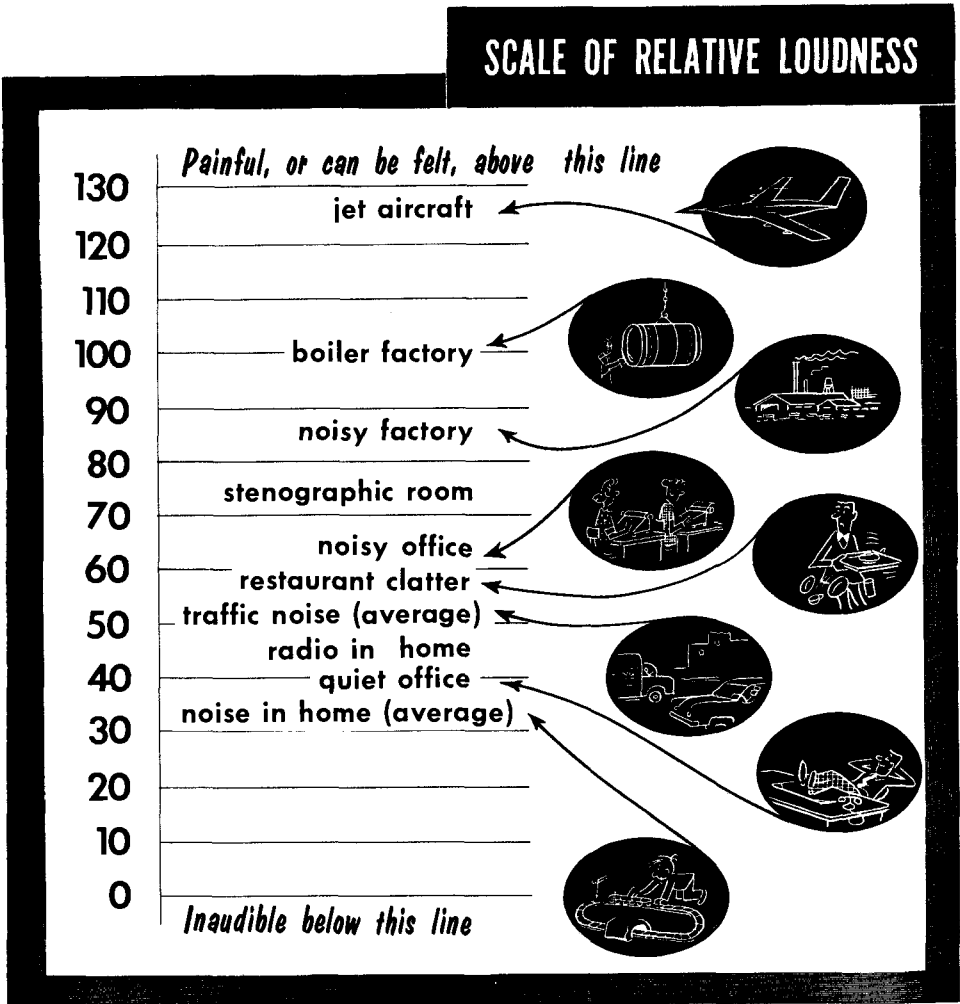

Every time that the intensity (or power) of a sound wave is *multiplied* by ten, it sounds louder by about the same amount. (It sounds as if a similar "quantity" of sound has been *added*.) A change in intensity of ten times does not represent as great a change in loudness as one might expect. In fact, a change in intensity of 26% is just barely detectible. The range between the intensity at which a 1000-cycle sound is first heard (the *threshold of hearing*) and a point at which an increase in power ceases to give the impression of further increase in loudness is a trillion times. Thus each multiplication of ten in intensity is equivalent to about one-twelfth of the range from audibility to saturation.

THE NATURE OF SOUND

Intensity and Loudness (contd.)

WHEN INTENSITY IS PLOTTED ON A LOG SCALE,

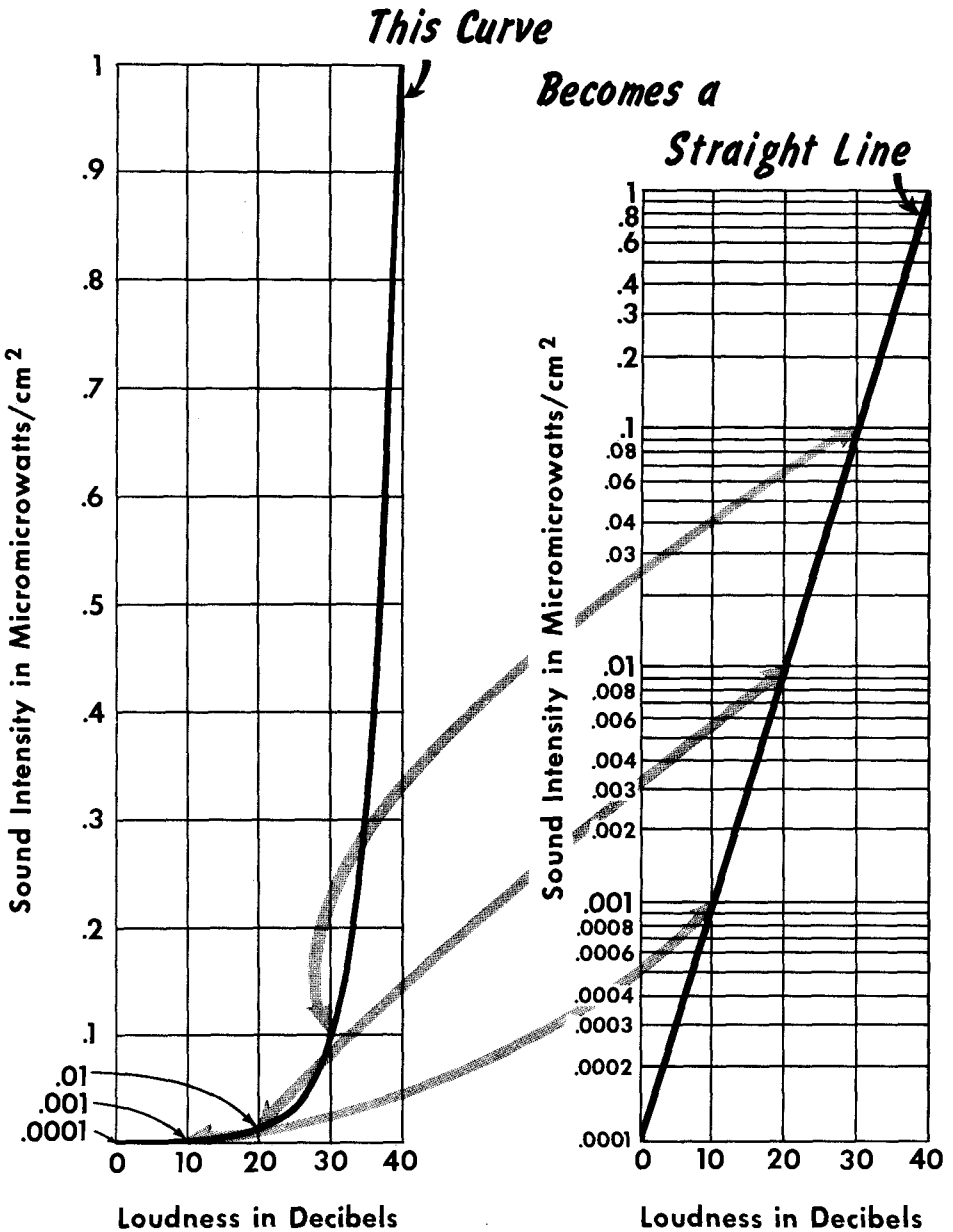

THE NATURE OF SOUND

Intensity and Loudness (contd.)

Loudness increases by equal amounts not with equal additions of sound intensity, but rather with equal multiplications of intensity. In this respect, therefore, our response to a change in intensity is similar to our response to a change in frequency—it is logarithmic. (Note the similarity of the graph of intensity and loudness to the graph of frequency and pitch; both are plotted on a logarithmic scale.) The fact that this logarithmic relationship exists is generalized in a principle known as Fechner's Law, which states that "For a sensation to increase in arithmetic proportion, the stimulus must increase in geometric progression." Fechner's Law may be applied to the other senses as well as to hearing.

The basis of the loudness scale is a multiplication factor of 10. This unit (called a *bel*) is inconveniently large, since there are only 12 bels in the entire useful range of audibility at 1000 cycles. For this reason, a smaller unit, the *decibel* (one-tenth of a bel) is more commonly used. (Thus the range of useful audibility at 1000 cycles is 120 decibels.) The decibel (abbreviated *db*) is also a convenient unit because it represents the 26% intensity change that is the smallest possible change an average person can hear in the range of loudness at which the ear is most sensitive to change. Over most of the range a 2-db change is difficult to detect, and at higher levels an even greater change is necessary.

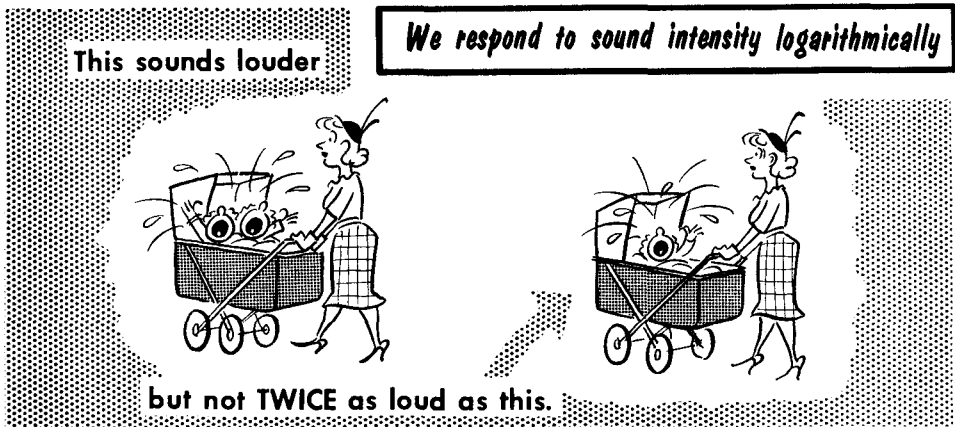

Because our response to sound intensity is logarithmic, our impression of loudness can be quite deceiving. If, for example, we are listening to the radio at low volume, we may not realize just how low the volume is, until an airplane passes over. The radio seems to become even less loud as the sound of the airplane drowns it out and our ears become less sensitive to the quieter sound. (This effect, known as *masking*, will be discussed in greater detail later.) Our instinctive reaction when this occurs is to turn up the volume control.

THE NATURE OF SOUND

Demonstration of Relative Loudness

With an ordinary linear resistor...

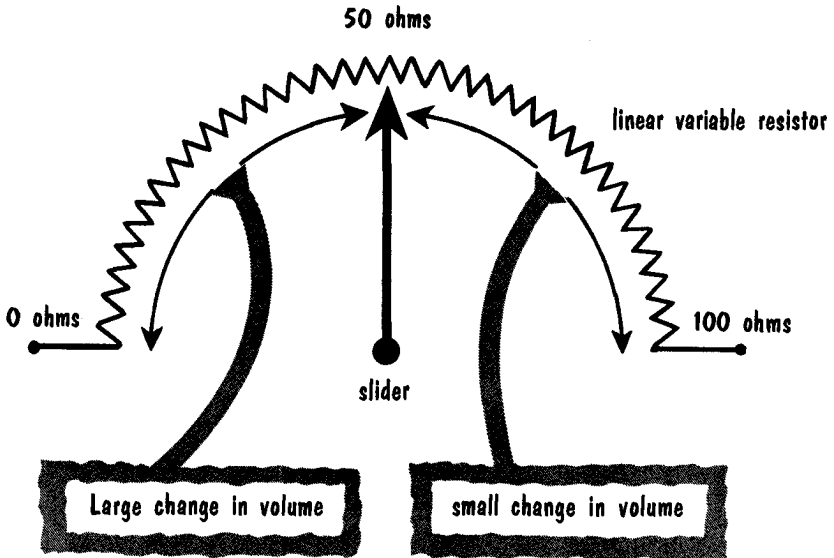

loudness does not vary in proportion to rotation.

This fact of the logarithmic sensation of loudness can be very easily demonstrated with a simple test, using an amplifier with a separate volume control and a loudspeaker. (A volume control is a resistor with a sliding contact; if an audio program is fed through the resistor and only part of it is picked off by means of the slider, the volume can be changed by moving the slider.) If the volume control is an ordinary variable resistor (with the resistance uniformly distributed), the intensity will be proportional to the angle between the slider position and the "zero" position. Using this kind of resistor for a volume control, the loudness does not sound as if it varies in direct proportion at all. In the first few degrees of rotation there is a big change in loudness, but further rotation makes hardly any additional change.

THE NATURE OF SOUND

Demonstration of Relative Loudness (contd.)

Comparison of **UNIFORM** and **LOGARITHMIC** RESISTORS

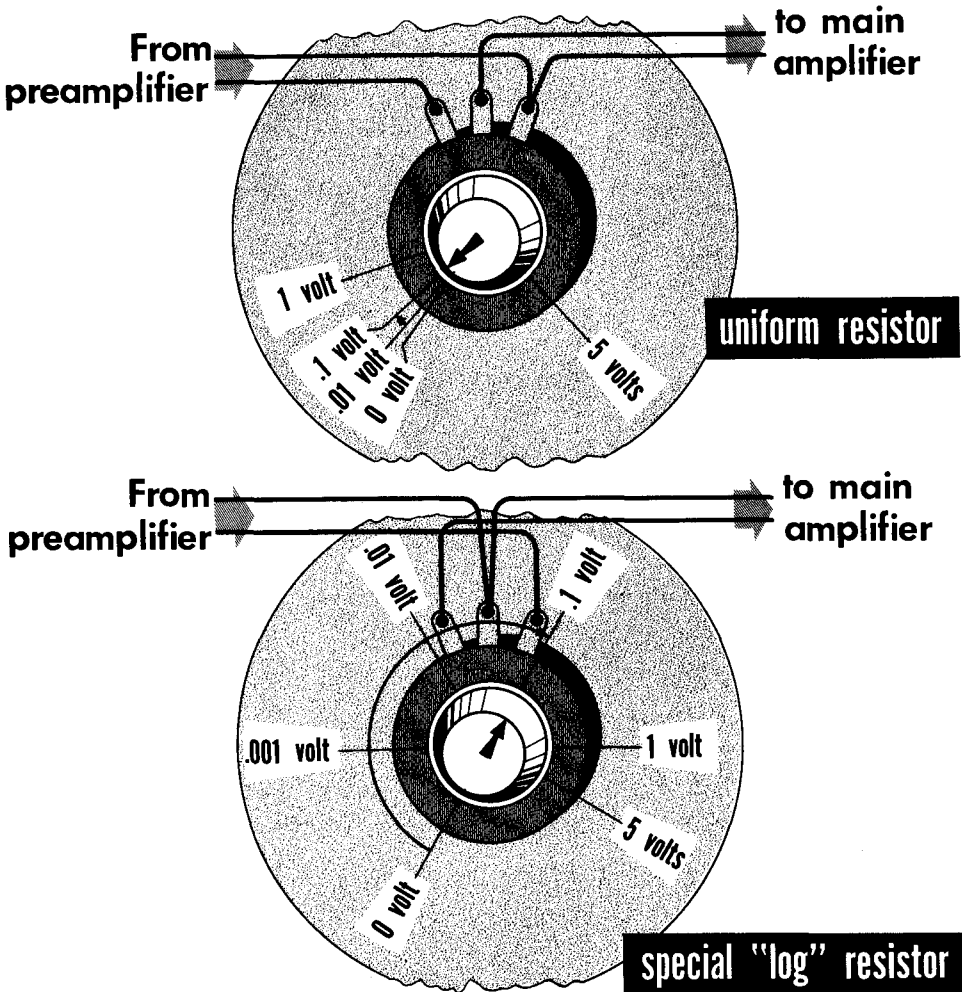

For this reason, variable resistors intended for use as volume controls are made differently. The resistance is not uniformly distributed, but rather is proportional to the *logarithm* of the angle of rotation from the zero end. Thus 50° of movement of the slider allows the passage of one-thousandth of a volt of audio signal; 100° may produce one-hundredth of a volt; 150° , one-tenth of a volt; 200° , one volt, and so on. When this kind of control is used, the volume, or loudness, seems to be proportional to the amount of rotation of the control.

THE NATURE OF SOUND

Harmonics or Overtones

We have described the two main properties of any single sound: frequency (which we recognize as pitch) and intensity (which we recognize as loudness). But there are other differences by which we can tell one sound from another, even if both are of the same frequency and intensity (pitch and loudness). For example, a violin and a flute do not sound the same, even when they play the same note equally loudly. The difference in sound *quality* or *timbre* arises from the fact that every note on any musical instrument consists of not just one frequency, but a combination of several frequencies.

A STRING VIBRATING IN DIFFERENT WAYS PRODUCES DIFFERENT OVERTONES.

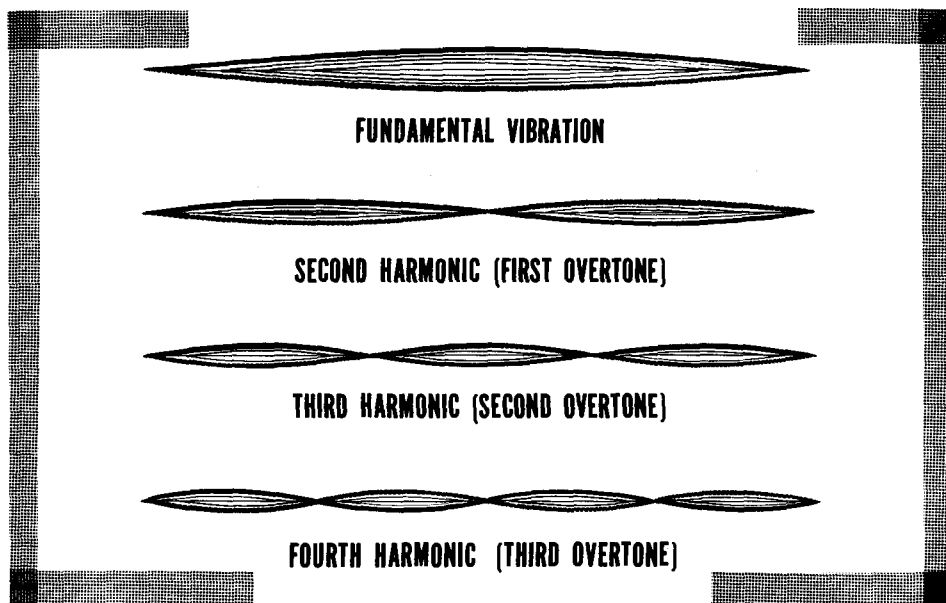

These additional frequencies are multiples of the lowest frequency (called the *fundamental*), which is usually the one that determines the pitch of the note. If the fundamental is 440 cycles per second (A above middle C), the same instrument will produce a range of frequencies that are multiples of 440 cycles at the same time: 2×440 , or 880 cycles, 3×440 , or 1320 cycles, and so on up the scale. What makes the different instruments easily distinguishable is the fact that these *overtones* (or *harmonics*) may be present in different relative intensities; some may be absent entirely. Each instrument has its own characteristic "selection" of overtones in characteristic relative intensities.

THE NATURE OF SOUND

Harmonics in Strings

That it is differences in the overtone structure that account for the different "sound" of various instruments can be verified with an electric guitar. With this instrument, the strings themselves produce relatively little sound. An electrical pickup placed close to the strings is used to pick up their vibration, which is amplified electronically, the sound being heard from a loudspeaker. If you take one of these guitars and try moving the pickup to different parts of the string, you will find that the *timbre* of the note changes.

Assume that after the string has been set vibrating, the amplitude of vibration of the string is 1/10 inch at the lowest frequency, 1/20 inch at the next above this, which is twice the frequency (the second harmonic or first overtone), 1/30 inch at the third harmonic or second overtone, 1/40 inch at the fourth harmonic or third overtone, and so on. Now suppose that we move the pickup to positions 1/10, 1/5, 1/4, and 1/3 of the length of the string from one end. The differences in timbre will be clearly audible. From the drawings we can find the magnitude of vibration at each point along the string for the fundamental and each harmonic. These can be made into a table:

Tone	Maximum vibration in inches	Vibration at pickup points in inches			
		one tenth	one fifth	one fourth	one third
Fundamental	.100	.031	.059	.071	.087
2nd harmonic	.050	.029	.048	.050	.043
3rd harmonic	.033	.027	.032	.024	.000
4th harmonic	.025	.024	.015	.000	.022
5th harmonic	.020	.020	.000	.014	.017

EXTENT OF VIBRATION at various pickup points FOR THE FIRST FIVE HARMONICS

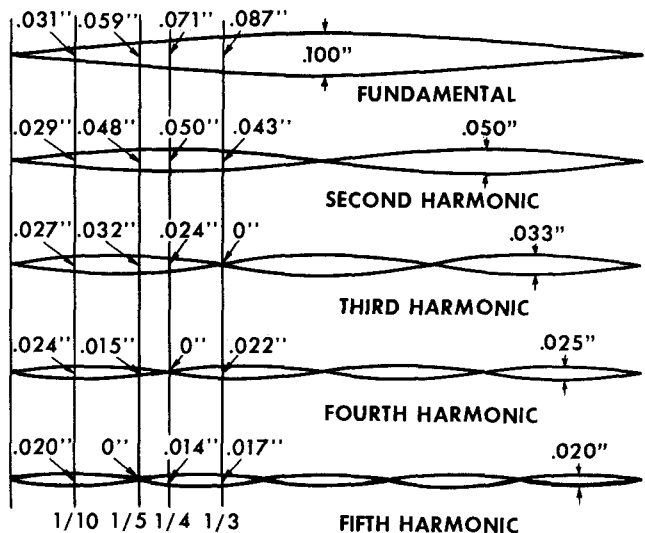

THE NATURE OF SOUND

Harmonics in Strings (contd.)

Of course there is less output from the positions nearer the end, but this can be compensated for by extra amplification, so the tonal quality, as judged by the ear, will depend on how much of each overtone there is, *compared to the fundamental*. Let us adjust the table to give this information, by expressing the strength of each harmonic as a percentage of fundamental. We do this by dividing each vibration figure by that for the fundamental at the same point, and multiplying by 100%. For example, when the fundamental vibrates 0.031 inch and the harmonic is 0.029 inch, the harmonic is $(0.029 \times 0.031) \times 100\% = 93.7\%$. The table, completed in this way, then looks like this:

Vibration percentages

Pickup point	Harmonics				
	Fundamental	2nd	3rd	4th	5th
one tenth	100	93.7	87.1	77.5	64.5
one fifth	100	81.4	54.3	25.4	0
one fourth	100	70.5	33.8	0	19.8
one third	100	50.0	0	25.0	20.0

Now notice the difference in composition: the first position, 1/10 from the end, gives a large proportion of all harmonics; even the fifth harmonic is more than half as strong as the fundamental. The second position, 1/5 from the end, eliminates fifth harmonic, and leaves the others in different strengths. Each position gives different proportions of harmonics. But the most important difference is that the further we go from the end, the weaker *all* the harmonics get, compared with the fundamental. At 1/10 from the end, all the harmonics have more than half the amplitude of the fundamental. At 1/3 from the end, only the second harmonic is even half as strong as the fundamental; the others are much weaker.

Harmonics
Pickup Points

PERCENTAGE DISTRIBUTION OF HARMONICS AT THE PICKUP POINTS

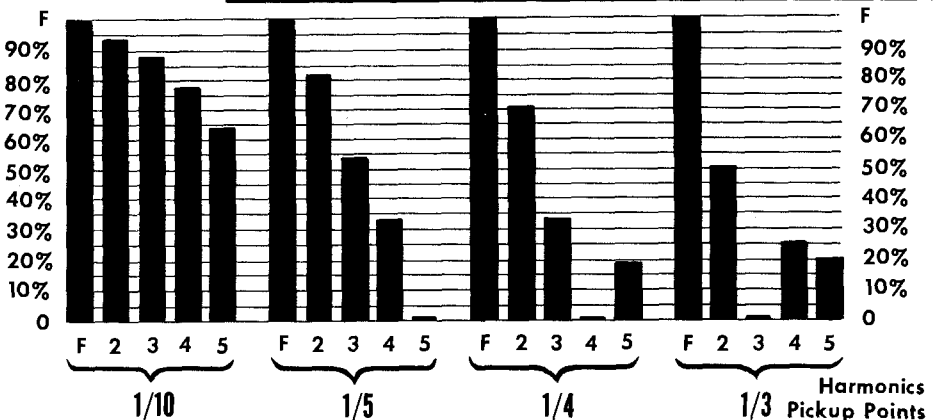

THE NATURE OF SOUND

Harmonics in Strings (contd.)

From this we can see that the tone quality, or timbre, of a stringed instrument will vary considerably if we change the point along the string where the sound is picked off. In most stringed instruments, the sound is taken from the bridge, which transmits it to the body of the instrument. This means that the pickup point is fixed.

WHEN THE PICKUP POINT IS FIXED,

Plucking here gives a brighter sound than plucking here.

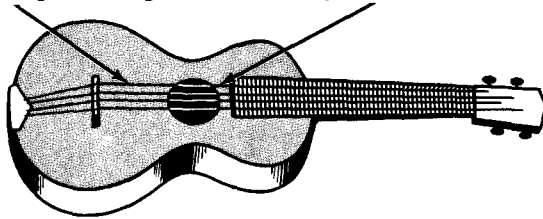

THE PLUCKING OR BOWING POINT AND THE

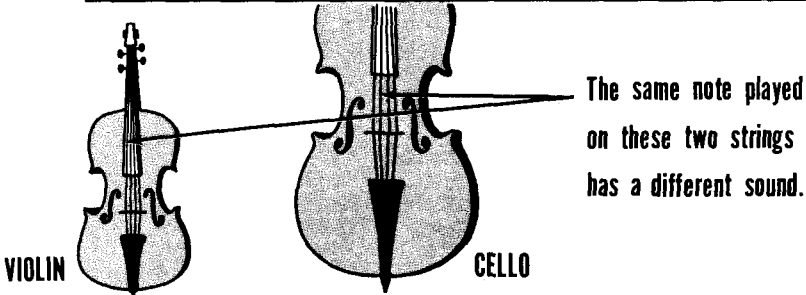

INSTRUMENT'S RESONANCES CONTROL TIMBRE

In this case, the precise point at which the string is plucked or bowed influences the harmonics or overtones of the string that are set in vibration together with the fundamental, thus changing the tone quality. In addition, the natural vibration properties of the body of the instrument (called resonances) influence the relative strength of the various frequency components as they are radiated into the air as sound. This accounts for the characteristic differences between different instruments using the same kind of strings.

We can extend the same general idea of overtones, and the way they are excited, to other kinds of instruments, using pipes, reeds, vibrating bars or rods, or other basic sound generators—even triangles, bells or drums. Variations in the complex pattern of harmonics give each instrument its own character.

THE NATURE OF SOUND

Harmonics in Organ Pipes

Variation in overtone structure makes different stops on an organ give different tonal qualities. In a pipe organ, the wide pipes produce tones in which the fundamental predominates. Their sounds are deep and smooth. The thinner pipes of the same length produce many more harmonics than the wider pipes, and give full-bodied sounds. Still thinner pipes suppress the fundamental and give a thin or reedy tone. In an electronic organ, the harmonics put in (or left out) are controlled electronically, giving a similar variety of "tone color."

The pattern of overtones produced by a pipe also depends on whether the far end of the pipe is open or closed. Acoustic vibration is set up in the air column by a sheet of air directed toward the upper lip of the pipe. When this air passes inside the lip, it starts to compress the air inside the pipe. This inside pressure soon forces the air out again. As a result, the blown air alternately goes inside and outside the pipe, with a considerable back and forth movement of air particles occurring at the pipe mouth.

The frequency of oscillation at the mouth is determined by the pipe. The pressure wave travels up the pipe at the speed of sound. When it gets to the far end, if the end is closed, the pressure increases because it cannot be passed on. The pressure wave is therefore reflected back toward the mouth of the pipe. When it reaches the mouth, the air directed against the lip is forced to go outside the pipe. Since this represents half of a complete cycle and the pressure wave has traveled twice the length of the pipe, it is clear that a closed organ pipe is one quarter-wavelength long for its lowest frequency.

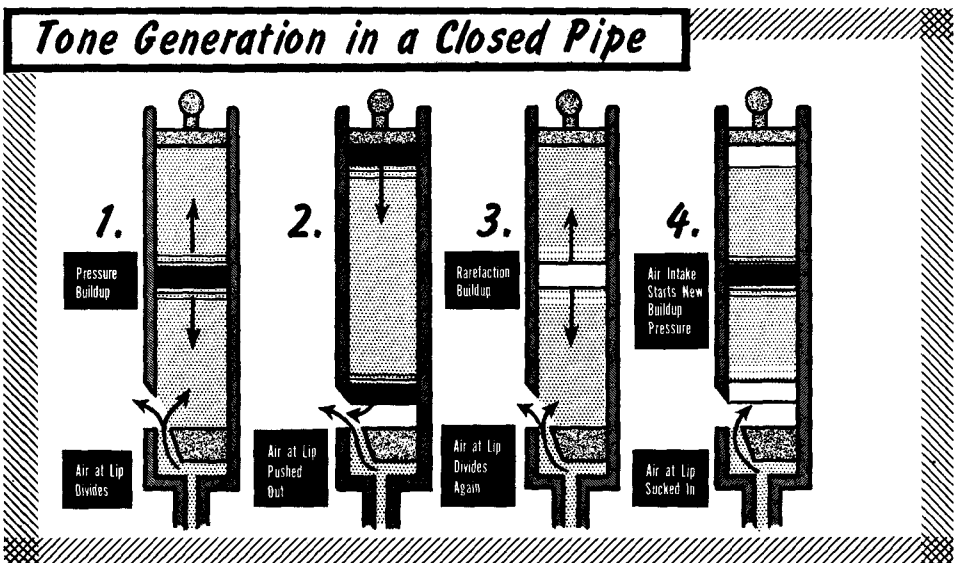

THE NATURE OF SOUND

Harmonics in Organ Pipes (contd.)

The air at the mouth of a closed pipe can move freely, whereas the air at the far end cannot move at all. Thus the lowest (fundamental) frequency of such pipes is determined by the length of a wave that travels up to the top, produces increased pressure, and travels back down the pipe to produce outward motion of air at the mouth.

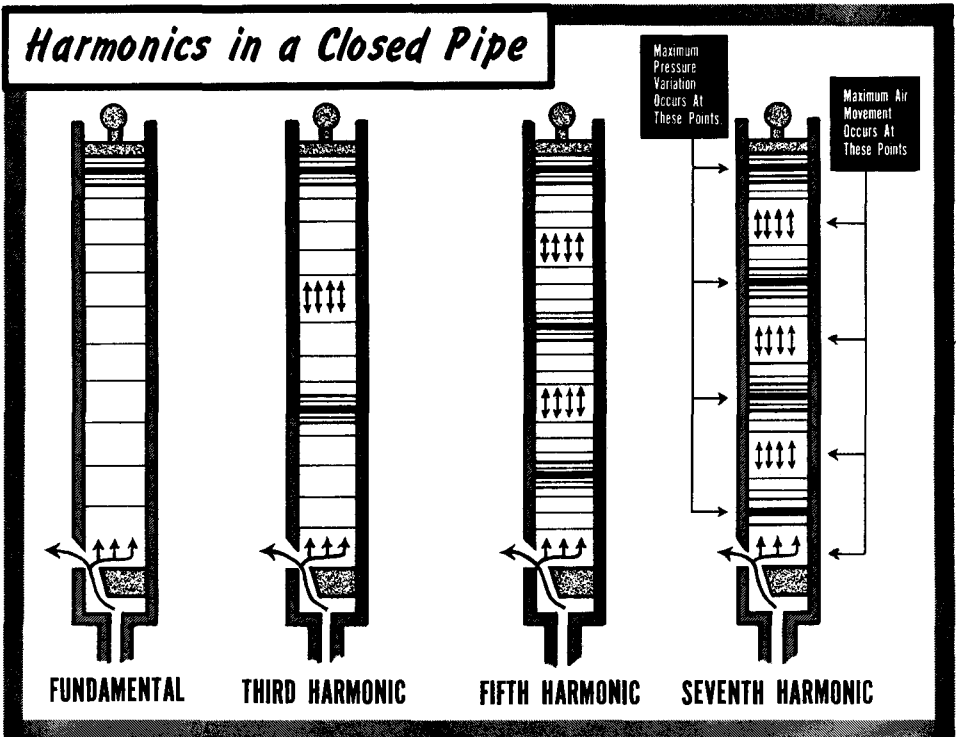

Any wave whose length is such that the return journey gets it to the mouth when the blown air is moving in the opposite way to the initial pulse—where the pipe is $\frac{1}{4}$ wavelength long, $\frac{3}{4}$ wavelength long, $1\frac{1}{4}$ wavelengths long, and so on—will tend to be present in the pipe. These wavelengths correspond to the *odd* harmonics of the fundamental. The even harmonics (whose wavelengths are such that the pipe is $1\frac{1}{2}$ wavelength long, 1 wavelength long, etc.) are absent. Notice that, at the mouth and for waves other than the fundamental, at half-wave distances along the pipe, the movement of air in the *going* wave adds to that in the return wave, to produce a point where air *movement* is a maximum. At the closed end, and for waves other than fundamental, at half-wave distances from the closed end, the air pressure in the going and returning waves adds, producing a point where air *pressure* fluctuation is a maximum.

THE NATURE OF SOUND

Harmonics in Organ Pipes (contd.)

If the far end of the pipe is open, the pressure will drop suddenly because the wave is no longer confined in the pipe. In this case, the pressure wave is reflected as a *rarefaction*. When the reflected wave reaches the mouth, the air blown against the lip is directed into the pipe again and thus completes a full cycle while the wave and its reflection have traveled twice the length of the pipe. Thus the fundamental frequency of an open pipe is such that the pipe is half a wavelength long. Any wave whose length is such that the length of the pipe is an exact multiple of a half-wavelength—1 wavelength, $1\frac{1}{2}$ wavelengths, etc.—can be sustained in an open pipe. These wavelengths correspond to all the harmonics of the fundamental frequency, and an open pipe produces a complete harmonic series.

TONE GENERATION AND HARMONICS IN AN OPEN PIPE

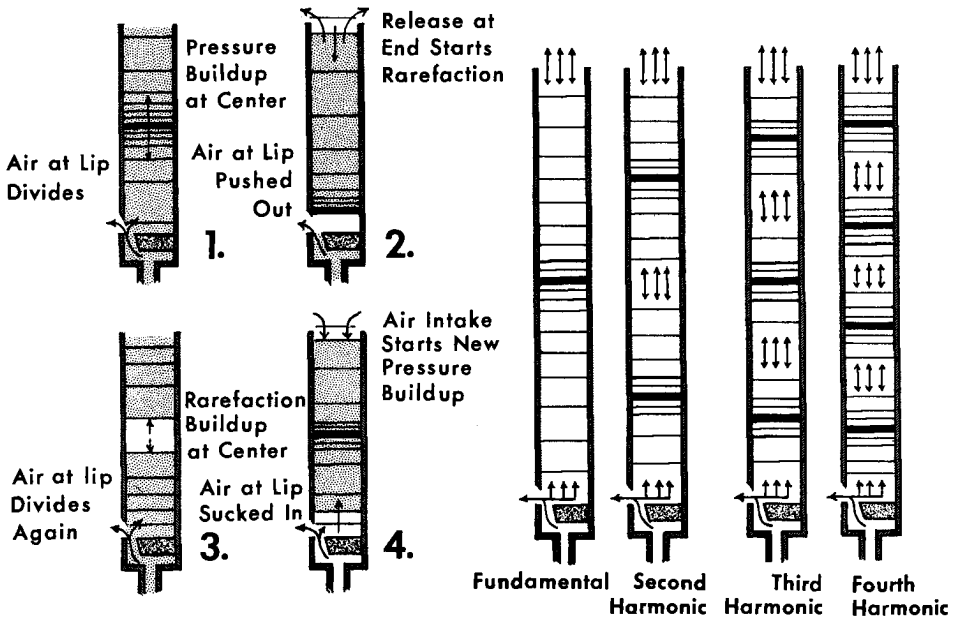

Just as in the closed pipe, there will be points where the pressures add up, and points where movements add up. Because of this action inside pipes, the waves do not seem to move. At the points where pressure has a maximum fluctuation, as at the end of a closed pipe, the air does not move, but changes in pressure according to the sound wave. At the points where movement is a maximum, as at the open end of an open pipe, or the mouth of either, there is little pressure fluctuation and a maximum of movement. For this reason, waves of this kind are called *standing waves*.

QUESTIONS AND PROBLEMS

1. What two kinds of air movement combine to produce sound waves? Illustrate with a wave started by bursting an inflated paper bag.
2. What two properties of air (or any other medium through which sound travels) control propagation velocity of sound waves?
3. How does the speed of sound change with (a) barometric pressure, (b) atmospheric temperature? State any approximate rule that can be used.
4. State why you think sound waves travel faster in steel than in iron or brick.
5. What part of (a) a piano, (b) a violin, is responsible for radiating sound waves into the air?
6. Explain the relationship (a) between frequency and pitch, (b) between intensity and loudness. What frequency interval corresponds with a pitch interval of one semitone in music?
7. What is the ratio between intensities corresponding to (a) the full range of average human hearing, (b) the smallest change in loudness that can be detected with very careful listening?
8. How would Question 7 be answered in decibel units?
9. How does Fechner's Law explain the usefulness of the decibel scale?
10. Why do potentiometers for use as volume controls have a logarithmic gradation?
11. What are the three basic properties of a musical tone? On what properties of sound does each of these properties depend?
12. Why can a string vibrate at more than one natural frequency? Explain the relationship between the different frequencies at which it can vibrate.
13. Why do you think strings for the lowest notes on the piano are "loaded" by having a spiral of wire wound on over the central stretched one?
14. Suggest why the same violin, played by an accomplished musician, gives a much sweeter tone than when played by a novice.
15. What is the basic difference in the overtone structure of organ pipes with the "far" end open or closed?
16. If the same pipe is provided with a removable end plug, how will its pitch change from open to closed?
17. Why is it that a narrow organ pipe sounds thin or reedy, while a wide pipe gives a deep, smooth tone?
18. What are standing waves? Explain how they build up inside (a) a closed and (b) an open organ pipe.

ACOUSTICS

What Rooms Do To Sound

Most of the sounds that we are concerned with in audio exist in rooms. But to understand what happens to sound in rooms, remember that echo that can be heard in the mountains. Every sound made comes back a few seconds later, like a perfect mimic. A wall-like face of rock reflects the sound waves that are generated, and sends them back one or more times.

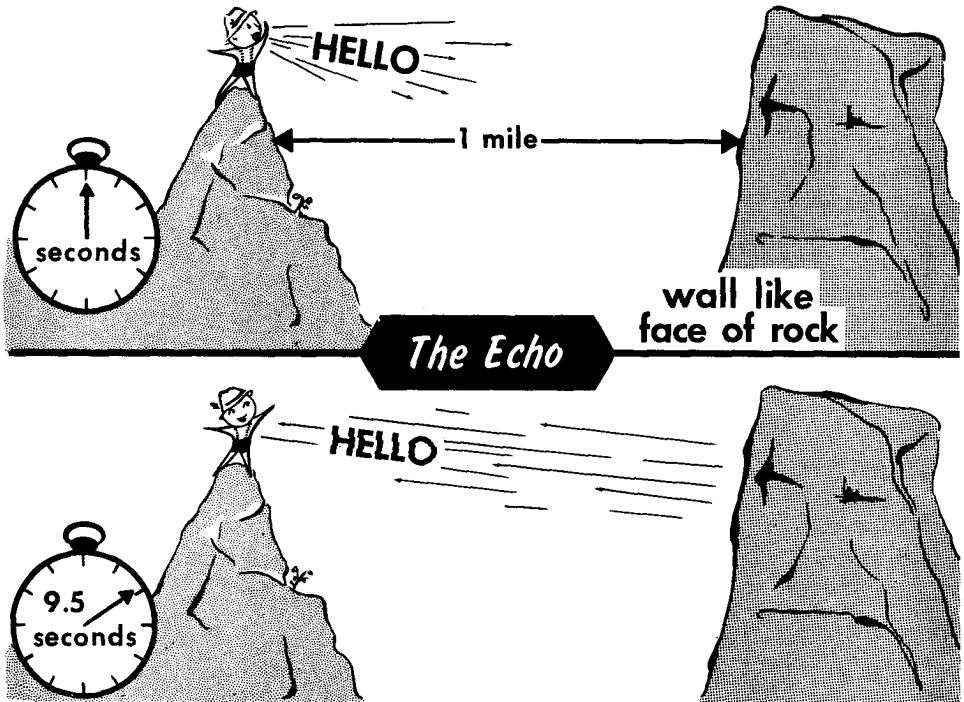

Because of the large open spaces in mountain areas and the time it takes sound to travel (about $4\frac{3}{4}$ seconds for each mile of travel), the reflected sound is heard so long after the original sound that it sounds quite separate from it. However, all surfaces reflect sound in the same way, even the walls in your living room. The difference is that the sound does not take so long in going to the reflecting surface and coming back, so the reflected sound does not get completely separated from the original sound.

You must have noticed at some time the difference in a room when all the furniture and rugs are removed (before moving into a new apartment or in preparation for the painters). Without the furniture and carpeting, the room sounds "hollow." When the furniture is in it, the room becomes pleasant to talk in. The hollow effect is due to the echo in the room from the wall surfaces. When the room is empty, the echo goes on bouncing from wall to wall a great many times; when the furniture is in, the echo is deadened.

ACOUSTICS

Why Sound Waves Reflect

Speed of Sound is Determined by Density and Elasticity of Medium

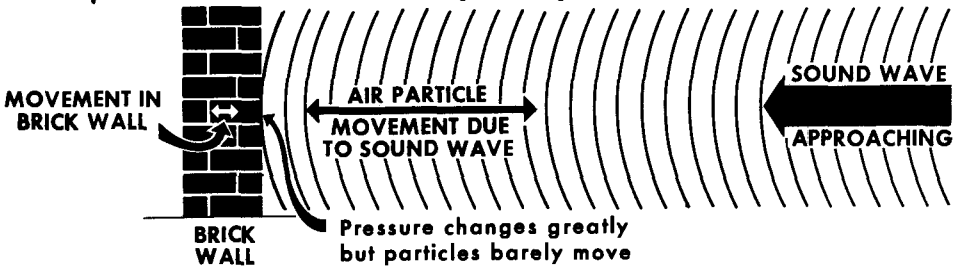

Sound will travel through anything except a vacuum, but the speed at which it travels is set by the density and elasticity of the material through which it is traveling. When sound, traveling in air, comes to the end of the air, it will start to penetrate whatever it strikes. The wave consists of both pressure and movement of the particles of the material through which it goes. The power in the given area of a sound wave is found by multiplying the pressure by the velocity, or rate of particle movement. Transmission in air uses a combination of large movement with small pressure, compared to transmission in, say, a brick wall.

Since the brick wall is much heavier, or denser, than air, the sound wave will not move the brick as much as it does the air. The pressure transmitted to the bricks will be the same as that built up in the air where it strikes them, but because the movement in the brick is very small, something different happens in the air where it touches the wall—it does not follow the same pressure and movement combination as air elsewhere, because the air hardly moves at all. This means that the pressure of the sound wave is almost doubled at this point. This "surplus" pressure starts another sound wave, directed away from the wall.

If the original wave strikes the wall at an angle, instead of "head on," the increase in pressure will follow the wave along the wall, as different parts of the original wavefront reach the wall. This results in the wave leaving the wall, just the same way that light gets reflected from a mirror.

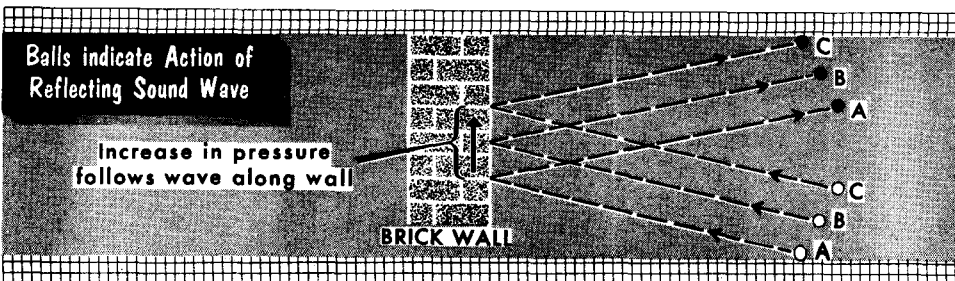

ACOUSTICS

The Ripple Tank

Waves of water in a tank are reflected in the same way. You can watch this at high tide, where the incoming waves of the ocean strike a breakwater at an angle. This gives a kind of slow-motion picture of what happens to sound waves.

Acoustic architects use ripple tanks for examination of the effects of various shapes in building structure on the way waves get reflected round an auditorium. It proves a useful way of working out a good shape for a building without having to make a full-scale model and then try all over again if the acoustics are improper.

Use of THE RIPPLE TANK

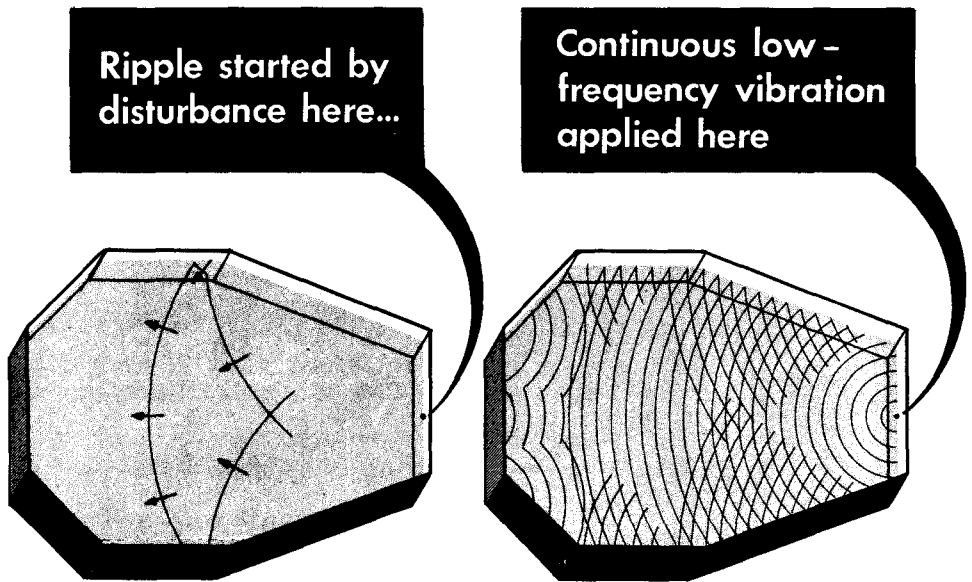

When a tone or sound is continued, reflection effects build up. A single clap, or other pulse of sound, is reflected in a sequence that can easily be traced in a ripple tank. To some extent, we can consciously discriminate between direct and reflected sounds in normal listening. But a continuous tone causes a sound *pattern* to be set up, called a *standing wave pattern*. This is similar to the standing wave set up inside an organ pipe, except that the one in the organ pipe is deliberately controlled and has a pattern in only one direction—along the pipe. Patterns in rooms or buildings are not so organized, and “stand” in several (at least two as a rule) directions across the room.

ACOUSTICS

Absorption

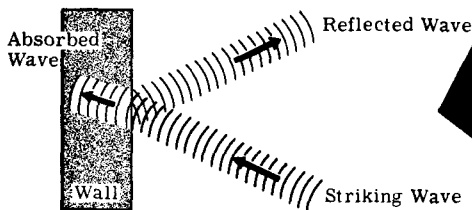

*When a sound wave changes medium,
some of it is Reflected, and
some of it is Absorbed*

Sound is never completely reflected. Some of it is also absorbed. If a sound wave hits the wall of a room, most of it will be reflected back into the room. Some of it, however, will go on into the wall. Some of it may even go out into the next room. This is the way sounds in one room can be heard in the next—through the wall.

Each time a wave encounters a change in medium, this happens. Some of it goes into the next medium; some of it gets reflected. The proportions depend on the differences between the two media (in the example, the air of the room and the substance of the wall), the wavelength of the sound waves, and the angle at which they strike.

If a sound wave is traveling parallel to a wall, the wavelength along the wall will be the same as in the wave traveling in air. Very little absorption will occur because the wavelength of the same frequency in the wall is much longer (since sound travels faster in the material of the wall).

If the wave hits the wall “head on,” the reflection and absorption will divide according to the density and elasticity of the wall material compared to air. But if the wave hits at a particular angle, the wavelength along the wall due to the striking wave may be the same as the natural wavelength for this wave in the wall.

Because this tends to make the wall take up more of the sound wave, there is a critical angle at which a sound wave will strike a surface, at which it will absorb much more than either a head-on strike or traveling parallel.

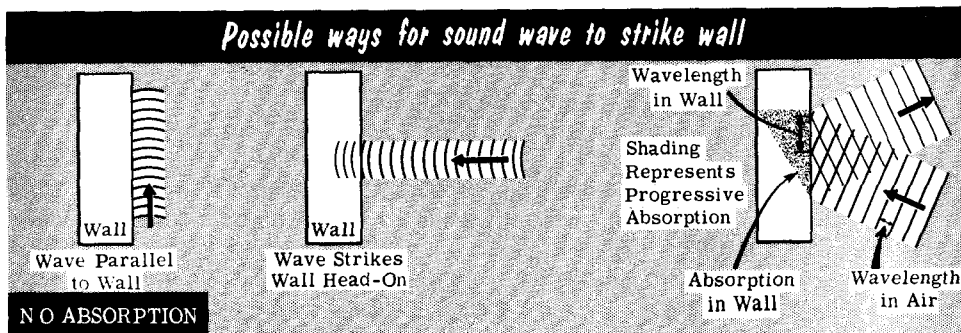

ACOUSTICS

Standing Waves

As a result of this standing wave pattern, the normally definite sense of direction that enables us to tell where sounds come from is lost. This can be verified with an oscillator, amplifier, and loudspeaker, or by just getting an instrumentalist to play a single long note. The sound seems to fill the room. If you have an impression that the sound comes from one direction (with your eyes shut) you are probably wrong, and if you move your head slightly, it will seem to come from a different place.

The Effect of Standing Waves

Cancellation occurs along the lines.

The + and - signs represent points of maximum intensity.

(When there is pressure at the points marked +, there is rarefaction at the points marked -.)

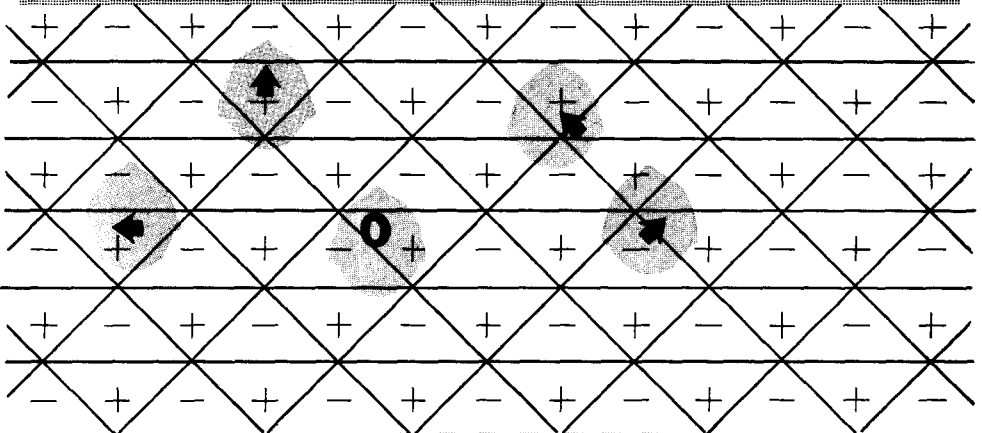

The arrows indicate the direction from which sound seems to come; the circle shows a position at which all sense of direction is lost.

If your head is placed where a maximum intensity occurs by your right ear, and the left ear is at a point of less intensity, the sound will seem to come from your right side. If both ears are on a line of maximum intensity, or are at equal intensity, the sound will seem to be in front of you. And if both ears receive pressure at the same intensity, but one receives a pressure wave when the other receives a rarefaction wave, and vice versa, the impression of direction is confused.

ACOUSTICS

Standing Waves (contd.)

Standing wave patterns take time to build up and, what is more important in acoustics, also take time to die away (*decay*). When the vibration causing the standing waves in the water ceases, or when the tone in the room stops, the vibrations all over the area die out gradually, rather in the way that a swinging pendulum comes to rest when nothing continues to drive it.

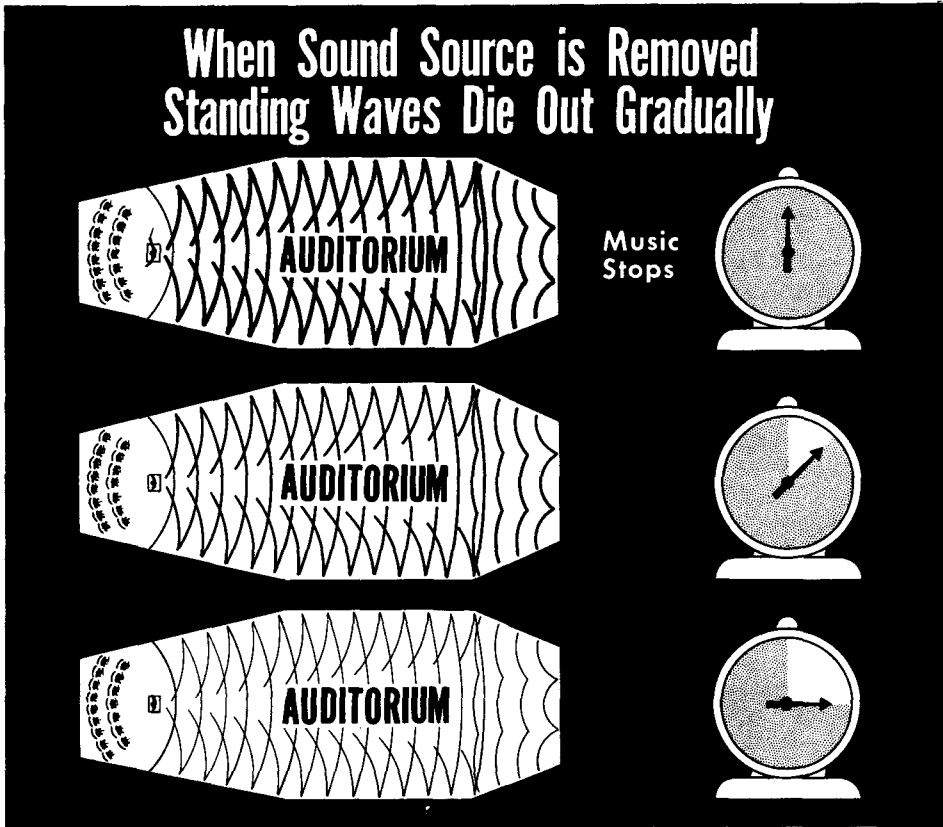

This dying away occurs in a fraction of a second in an ordinary living room. Most of us are so used to the brief presence of these patterns that we do not normally notice it. In a large hall or auditorium, however, or in a stadium with walls all around it, the time required for sound to die away can be quite noticeable.

The time required for sound to die away after the originating tone ceases is called the *reverberation time* of the room or building. (Reverberation is the name given to "echo" when it is not sufficiently separated from the original sound to be noticed as a separate repetition.)

ACOUSTICS

The Inverse-Square Law

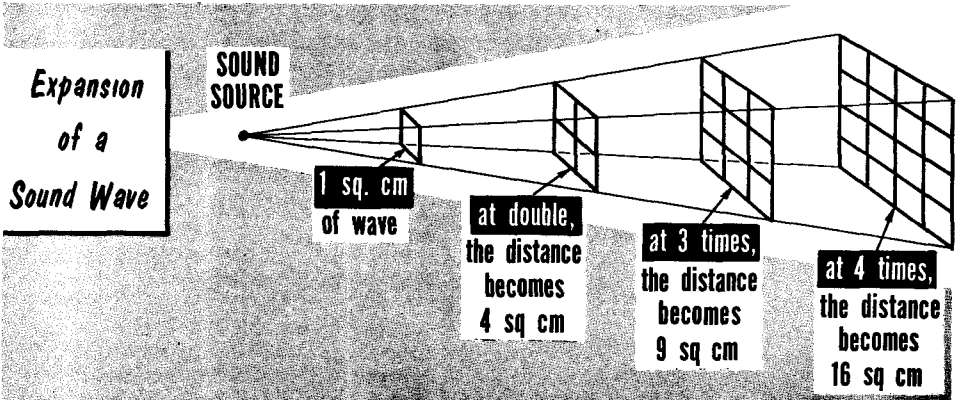

In the absence of any reverberation, the sound goes on outwards in an ever-expanding wave. The farther the wave goes from its starting point the larger its area becomes. The energy in the wave does not increase, because the wave can only pass on the original amount of energy put into it. This means the intensity in a *square centimeter* of the wave (which is how intensity is measured) must decrease as we go farther from the source. It is like spreading a fixed amount of butter on two slices of bread. If one slice is larger than the other, the butter on it will be thinner.

Doubling the distance means the area is quadrupled, so the intensity must be divided by four. Multiplying the distance by any number means that the area is increased by the square of that number, which, in turn, means that the intensity must be divided by the square of the number. This fact is known as the *inverse-square law*.

The Inverse Square Law

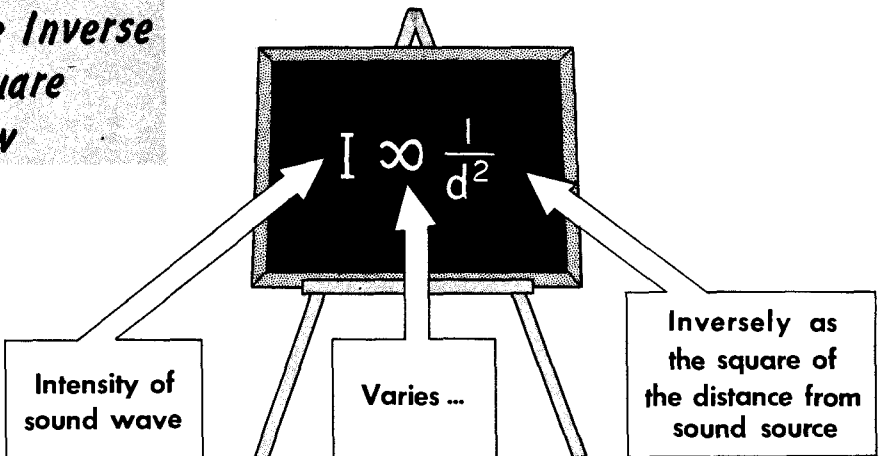

ACOUSTICS

The Inverse-Square Law (contd.)

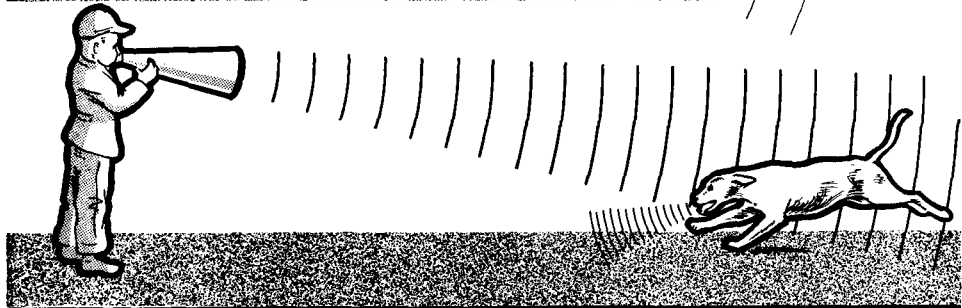
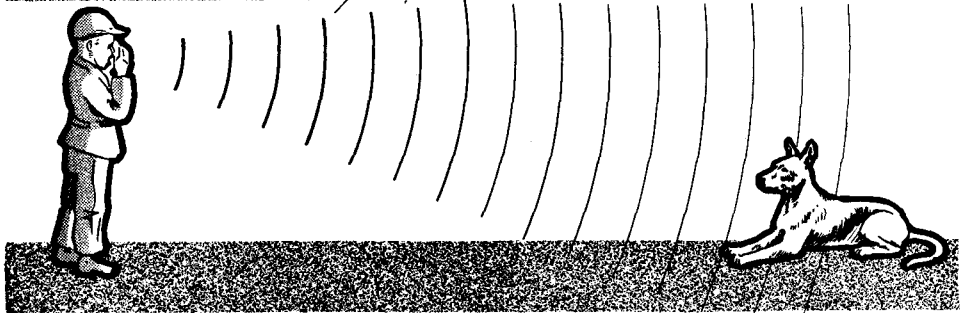
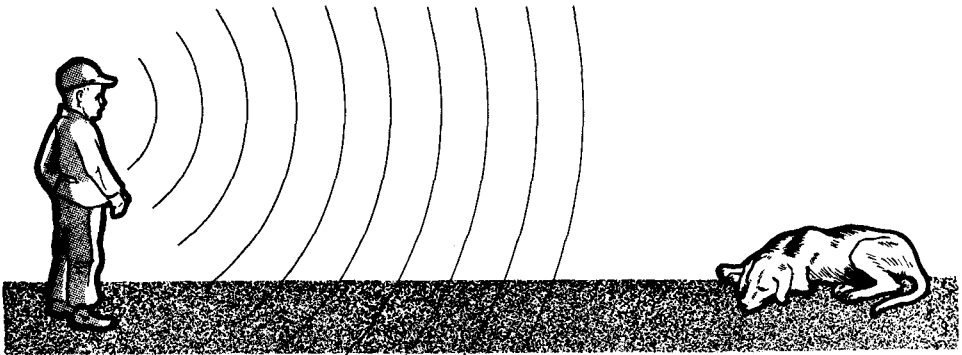

*Concentrating Sound into narrower angle
permits sound to carry further*

The inverse-square law gives one reason why sound does not carry very far in the open air, unless there is something to make an echo. Cupping your hands or using a megaphone concentrates more of the original sound within a narrower angle, so that the power does not get scattered quite so widely. For this reason, the sound carries further in a particular direction. Because of reflection and reverberation effects, sound does not get "lost" so readily indoors.

ACOUSTICS

Masking

Although there is a big power difference from the quietest audible sound to the loudest that the ear can negotiate—about 1,000,000,000,000 times—we cannot listen effectively to both a very soft and a very loud sound at the same time. If sound A is too much louder than sound B, A drowns B out. The scientific name for this effect is *masking*.



While it is sometimes a matter of getting the sound we *want* to hear loud enough to be audible against a noisy background, at other times—when we want to listen to a high fidelity reproducer, for instance—our object is to get the sound loud enough so that we do *not* hear other, *unwanted* sounds. Or, more specifically, we wish to get the unwanted sounds so quiet that they cannot be heard while we listen to the music.

ACOUSTICS

Outdoor Acoustics

Have you ever wondered why sound travels much better “downwind” than against the wind? With sound traveling at about 750 miles an hour, a wind of only a few miles an hour will obviously not be able to *stop* the sound, although the speed of sound relative to the ground does vary with the wind speed.

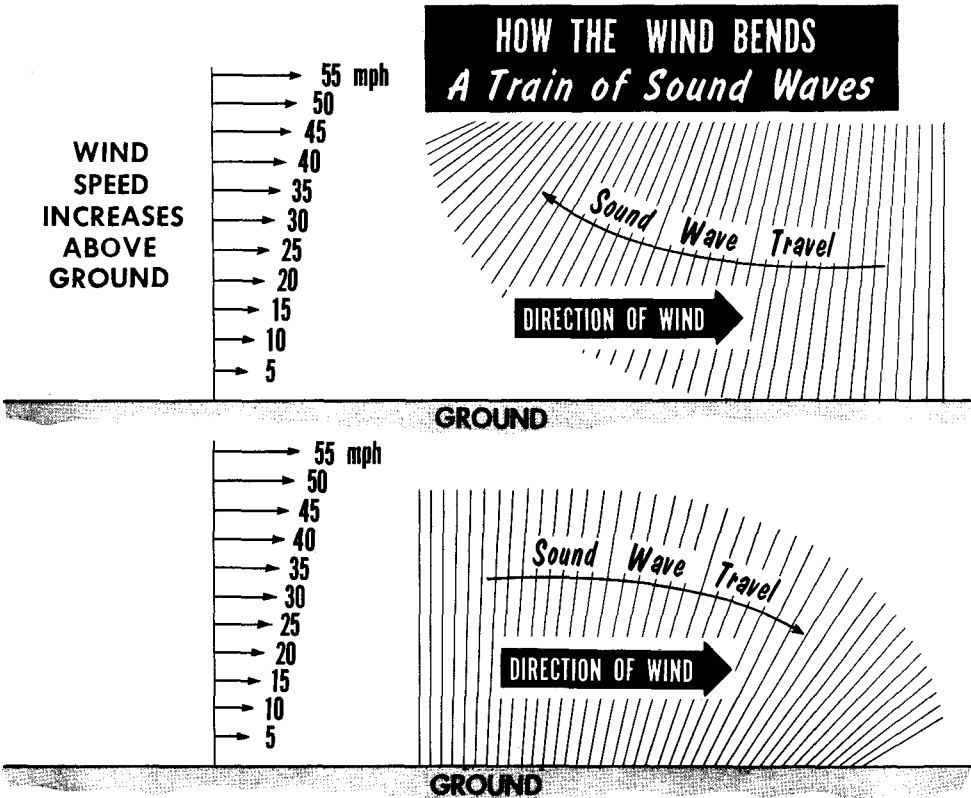

The wind travels at different speeds at various heights above ground. Air in contact with the ground hardly moves at all, but the higher you go, the stronger the wind. For this reason, the higher part of the sound wave traveling *with* the wind moves faster than the part near the ground. (The wind speed is added to the normal speed of sound.) This makes the wave lean forward, and bear down on the ground, and the sound heard here is more intense than without the wind.

Traveling *against* the wind, sound at higher levels moves a little slower than on the ground, the wave leans back. It therefore “takes off” and does not carry to a listener on the ground.

ACOUSTICS

Listening Acoustics

It might be thought that to enjoy listening best, we should go outdoors where there is no reverberation. But in most outdoor locations, there is so much other noise going on, and the sound we want to listen to gets lost so quickly in all directions that we will not be satisfied. However, some quiet country locations are ideal for listening to music, which accounts for the increase in popularity of summer outdoor music festivals.

Quiet Country Locations are ideal for Music Listening

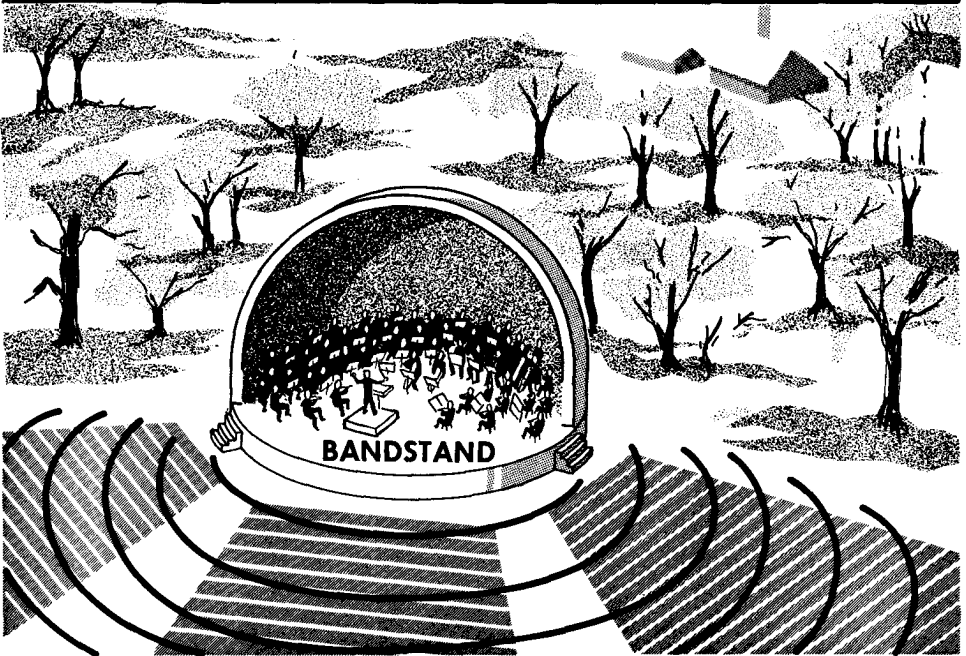

Using a room to listen in, whether it be our living room or an auditorium, helps to keep in the sound we want to hear, and to keep out what we don't want to hear. Reverberation helps to build up the intensity of the sound we want to hear, but there is a limit to the useful amount of reverberation. If we have too much, the sound seems to go on and on and on. Each new sound is blurred by the reverberation of the sounds that preceded it.

This phenomenon is closely linked with masking: reverberation should build up the sound, but not so much that it masks the original sound or succeeding ones. Every size of room or auditorium has an optimum amount of reverberation and length of reverberation time for music or speech that will give the most enjoyment from listening.

ACOUSTICS

Sound Composition

Every sound has its own individual composition: different frequencies at varying intensities, and recurring at intervals. Musical instruments have a definite pitch range, from the lowest note to the highest note that each of them can play. Above each note there is a range of overtones which must also be heard if we are to distinguish one instrument from others playing the same note.

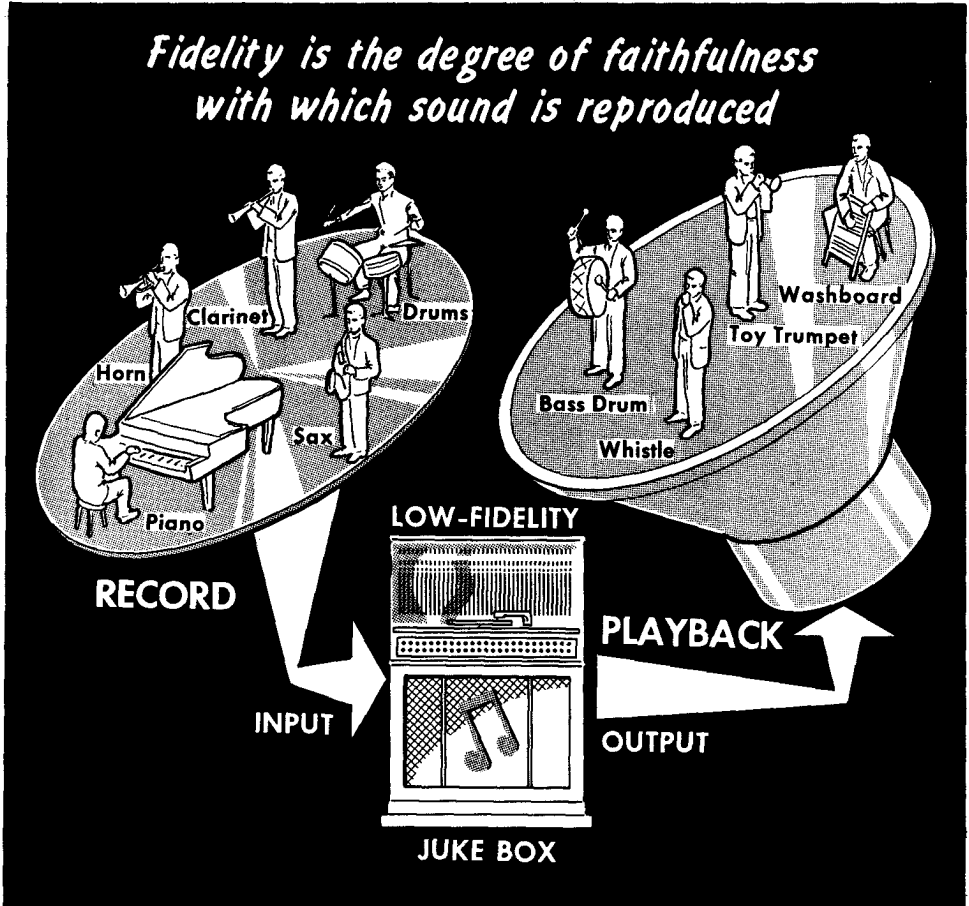

The faithfulness with which the sound reproduced through a loudspeaker copies the original is called the *fidelity* of the system. If all the original frequencies are present in their original proportions, the system has "high fidelity." In the average juke box—especially the older ones—the fidelity is very low. The tune, of course, can be recognized, but you would have difficulty in recognizing some of the instruments playing it.

ACOUSTICS

Directional Effects

Hearing all sounds in correct proportion is not only a matter of making sure that they come out of the loudspeaker that way. Different frequencies do not travel in rooms in quite the same way, so we may notice some peculiar effects because all the frequencies do not reach us properly.

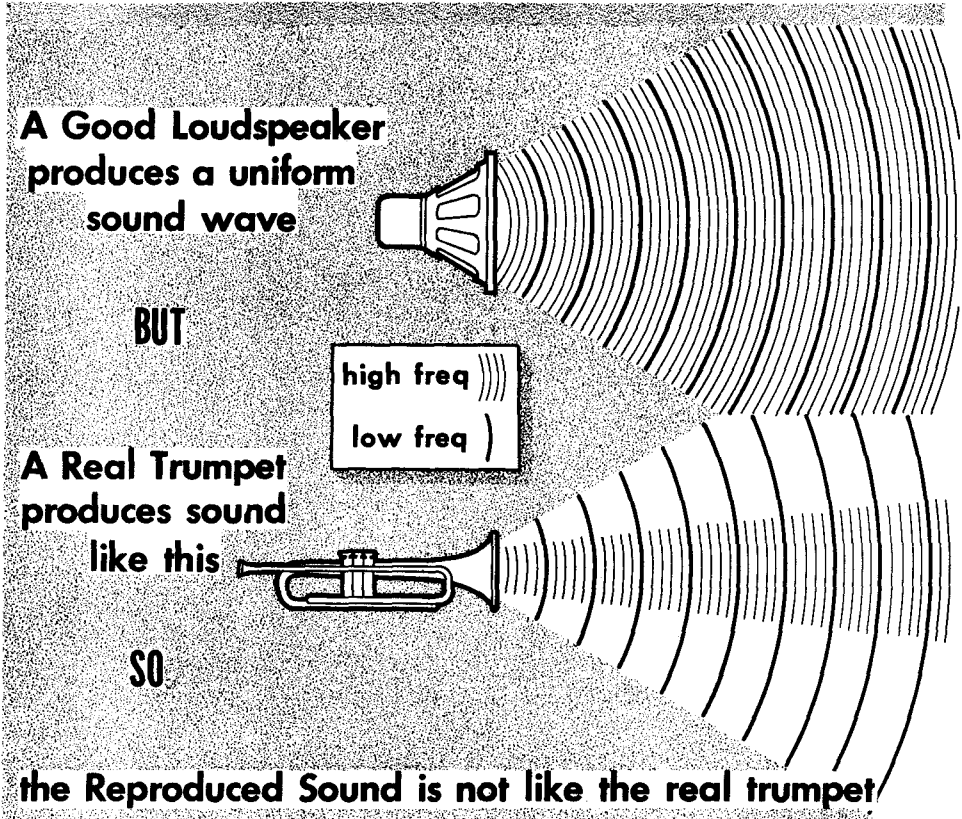

For example, a trumpet gives out sound that is very rich in overtones. The lower (fundamental) notes of the trumpet go out in all directions, whereas the high-frequency sound is almost squirted in the direction in which the trumpet is pointed. This kind of sound production and the way in which the sound bounces around before reaching our ears have become part of our experience in listening to trumpets.

If a loudspeaker radiates all the correct frequencies to make up a trumpet sound, but distributes the high frequencies in all directions (in the same way as it does the lower frequencies), reproduction of the trumpet will not be realistic.

ACOUSTICS

Frequency and Wavelength

All sounds travel at the same speed, regardless of frequency. Because the waves are traveling, the length of a wave (measured along the direction it travels) from the peak of one wave to the peak of the next will be different, according to the frequency.

WAVELENGTH AND FREQUENCY

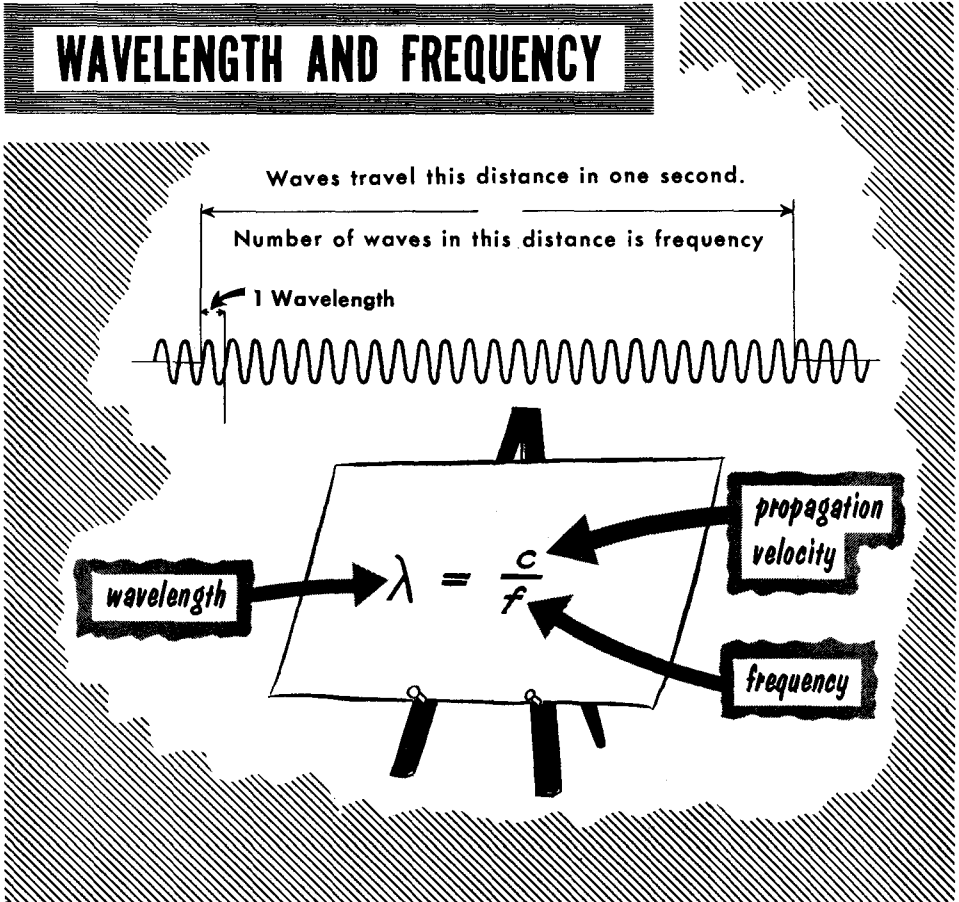

Sound moves at about 1100 feet per second. If the frequency of a sound is 440 cycles per second (A above middle C), there must be 440 cycles in a 1100-foot piece of the sound wave. Each wave is thus about $2\frac{1}{2}$ feet long in this case. If the frequency is 8800 cycles (an octave beyond the end of a piano keyboard) the same space (1100 feet) will be occupied by 8800 cycles, or waves, and each must be only one eighth of a foot (about $1\frac{1}{2}$ inches) long. Low frequencies from organ pipes may be down in the region of 32 cycles, with a wavelength of 34 feet.

ACOUSTICS

Long and Short Sound Waves

Many Rooms do not permit a complete Cycle of a Low Frequency

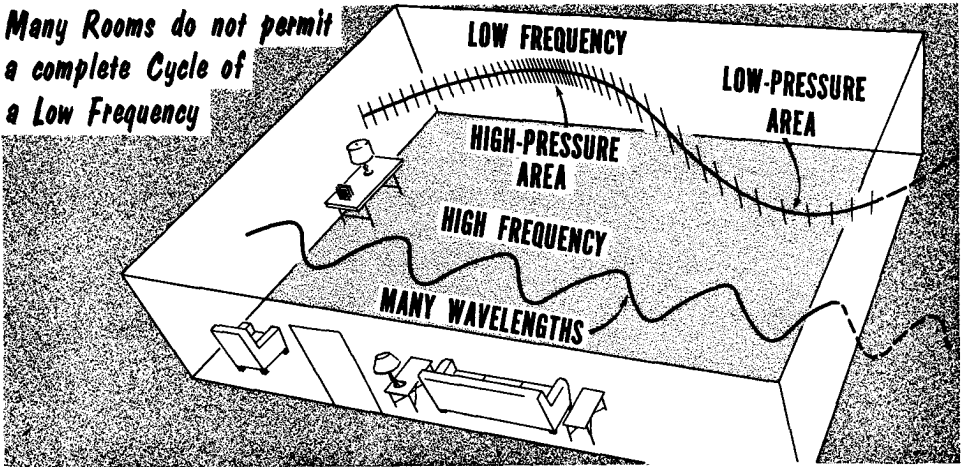

As a result of the tremendous differences in wavelength, the low frequencies may not even have one complete wave in an average-sized room at the same instant, whereas a high-frequency sound will have many complete waves in the room traveling in a number of directions at the same time.

Because of its size, a low-frequency wave can hardly be recognized as such in a comparatively small room—it is more like a fluctuating pressure throughout the whole room at the same time. For this reason, it will fill the room, regardless of the room's shape. The higher frequencies, however, since they are smaller than most objects, such as walls and furniture, will be reflected whenever they strike a surface. For this reason, you may miss some of the high frequencies, not because they are not present, but because you happen to be sitting in a *shadow zone*.

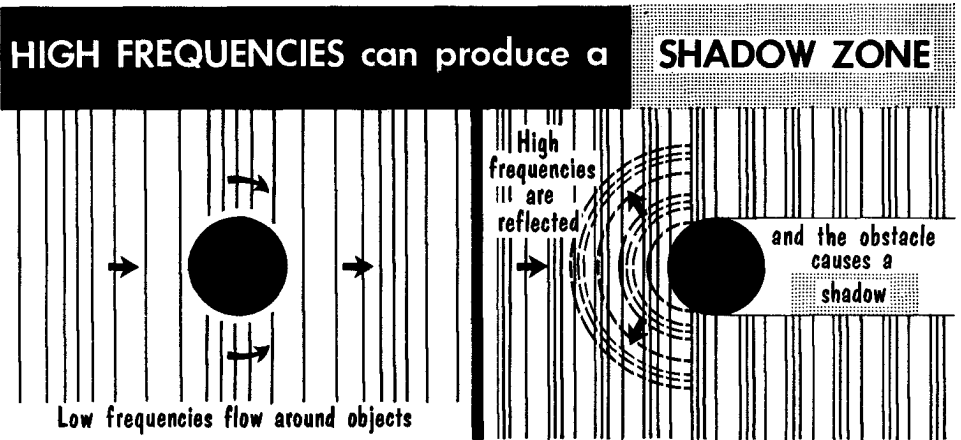

ACOUSTICS

Transients

The word “transient” means something that is passing or changing. Within the strict meaning of the word, any change, from silence to sound, for example, or from sound back to silence, would be classified as a transient, while the steady, unchanging tone is not a transient.

TRANSIENTS are IMPACT SOUNDS



and get Attention more effectively than do Steady Tones

In audio, for two reasons, the word is used with a somewhat more restricted meaning. The first is connected with everyday listening experience, the second with the performance of audio equipment—microphones, amplifiers, loudspeakers, etc.

The start of any sound, whether sudden or gradual, will reach a listener before the reinforcement of the same sound by reverberation. When the sound finishes, the reverberation goes on. Because this happens all the time around us, our hearing faculty has formed the subconscious habit of paying more critical attention to the beginning of sounds than to the endings.

If the sound builds up relatively slowly, as in the deep notes of a pipe organ, the reverberation builds up almost as rapidly as the direct sound from the pipe. On the other hand, a sound that starts suddenly, like a hand clap, a drum beat, or any sound that has what we may call “impact,” reaches the listener well ahead of its reverberation, and gives him a good chance to tell where it came from. Thus musical sounds that have impact, like a hand clap, can be regarded as attention-getting sounds.

ACOUSTICS

Transients (contd.)

Sounds Produced by 'Suddenness' are Transients

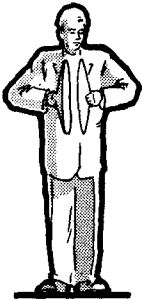

CYMBALS

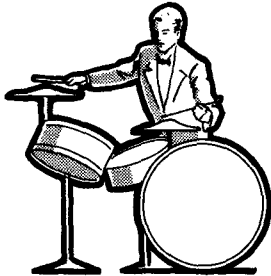

DRUMS



BASS



BANJO

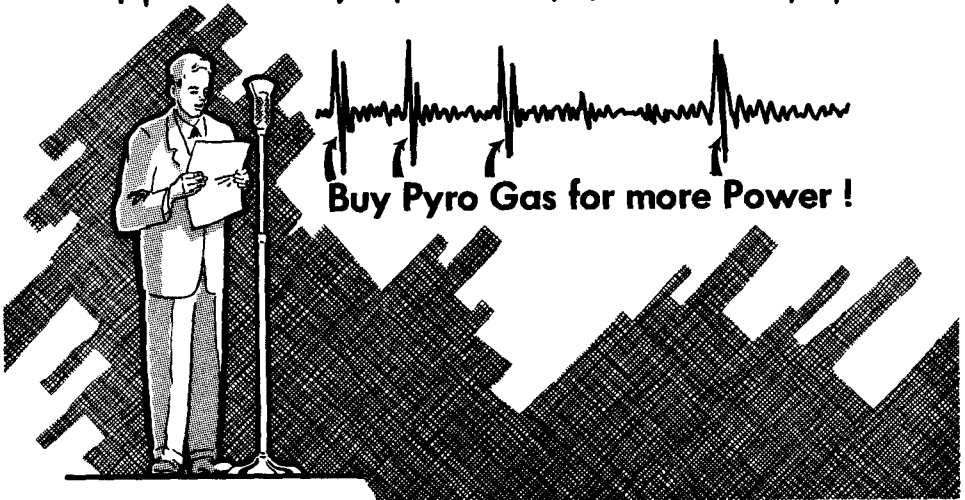

Any sound distinguished by suddenness is thus a transient: all of the percussion instruments, drums, cymbal, etc., as well as plucked or struck strings; and in speech, the sounds made in pronouncing the letters, b, d, g, k, p, t, are always transients. (Other consonants sometimes are too.)

The second reason for paying attention to this more restricted kind of transient is that audio equipment has particular problems in handling these more "sudden" types of sound, as compared with steady tones of unchanging, or relatively slowly changing, frequency or intensity.

ACOUSTICS

Background

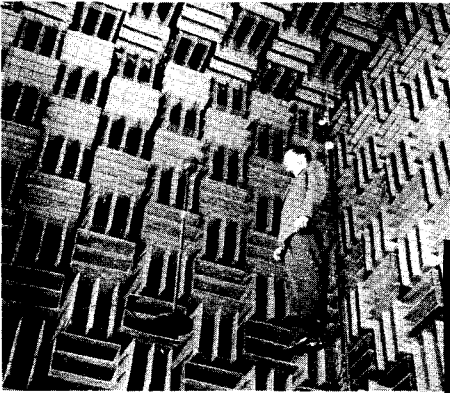

Loss of background sounds due to excessive absorption -- such as in an Anechoic Room create a loss of perspective

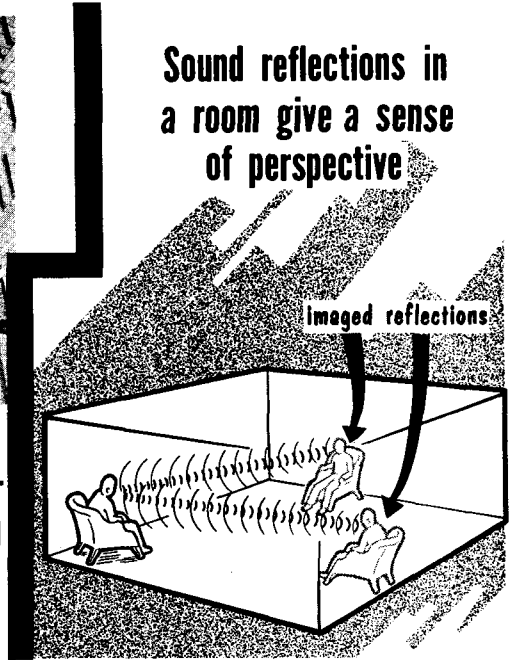

Although reverberation makes the endings of sounds less important than their beginnings, this does not mean we can ignore the endings. Human hearing is very conscious of the reverberation even though it may not listen to it so critically.

You notice nothing unnatural about talking in an open field. There is no echo to your voice because the sound of it can keep on going without being reflected. You also notice nothing unnatural about talking in a room where there is a very definite echo, or reverberation, to your voice. But try talking in an anechoic room (a room used for acoustic testing in which walls, floors, and ceiling are made completely absorbant of sound); try one of those padded rooms they use for violent cases in mental institutions (if you ever have the opportunity). Either of these places will give you a quite unnatural sensation of "soundlessness," rather than of silence.

When you are outdoors, it may be quiet but there are little sounds going on that give you a subconscious perspective of where you are: birds singing in summertime or other incidental sounds that are usually "in the background" outdoors. When you are indoors the reverberation of your own voice subconsciously tells you what kind of room you are in. But in the padded cell or anechoic room, because of the excessive absorption that removes all background sound, either from outside or from your own voice, you feel your voice is "lost." There is no background to give you perspective.

ACOUSTICS

Amplification

Normal sound vibrations are very small—so small that the movement of a loudspeaker diaphragm is not visible, except at the lower frequencies. The only reason that sound can be transmitted so efficiently with such small movements is that it uses the natural transmission speed of the air. Nonetheless, the magnitude of movement of the particles diminishes with distance traveled (recall the inverse-square law). Although hearing covers a very wide range of intensity variation, sound will only carry a certain distance before it becomes inaudible.

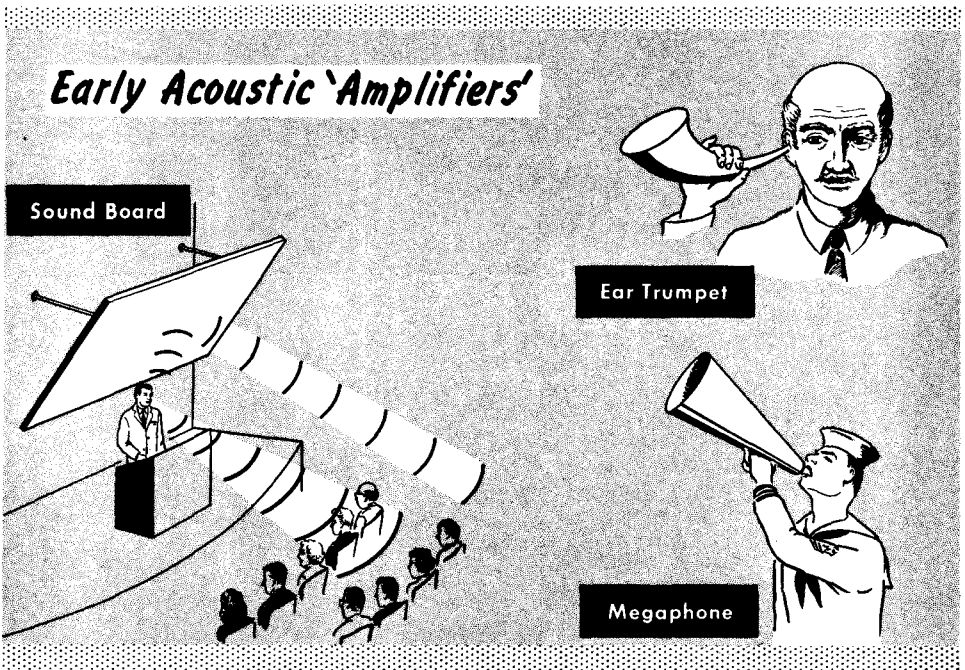

From earliest times man has had this problem to overcome. Long before electronic amplifiers became possible, some kinds of acoustic “amplifiers” were used. Actually these were not amplifiers in the true sense of the word—they did not increase the sound power but merely conserved what power was available. The ear trumpet, for example, collects a larger area of the sound wave and thus increases the intensity at the earpiece. The megaphone concentrates sound at the sending end, to restrict it within a narrow angle. The sound in front of the megaphone is louder, but you can hear less than normal in all other directions. The speaking tube is more efficient; it virtually prevents any sound escaping at all, so that all the power is conveyed along the tube. In this way, sound can be transmitted for considerable distances. The reflector board over the speaker’s platform serves a purpose similar to the megaphone by making use of sound that otherwise would escape upwards.

ACOUSTICS

Amplification (contd.)

An early attempt at real amplification, (the *pneumatic amplifier*) was entirely acoustic. Sound vibrations striking a diaphragm were used to operate a valve, somewhat like a reed, through which air under pressure was driven. The amount of air passed by the reed was controlled, or “modulated” by the sound vibrations reaching the diaphragm, and produced a more intense replica of the original sound.

The amplification given was rather crude. The apparatus was far less convenient than modern electrical, or electronic amplification. The “microphone” and “loudspeaker” had to be mechanically coupled, and thus close together. It could not be used for as many purposes, and its quality was rather rough, to say the least.

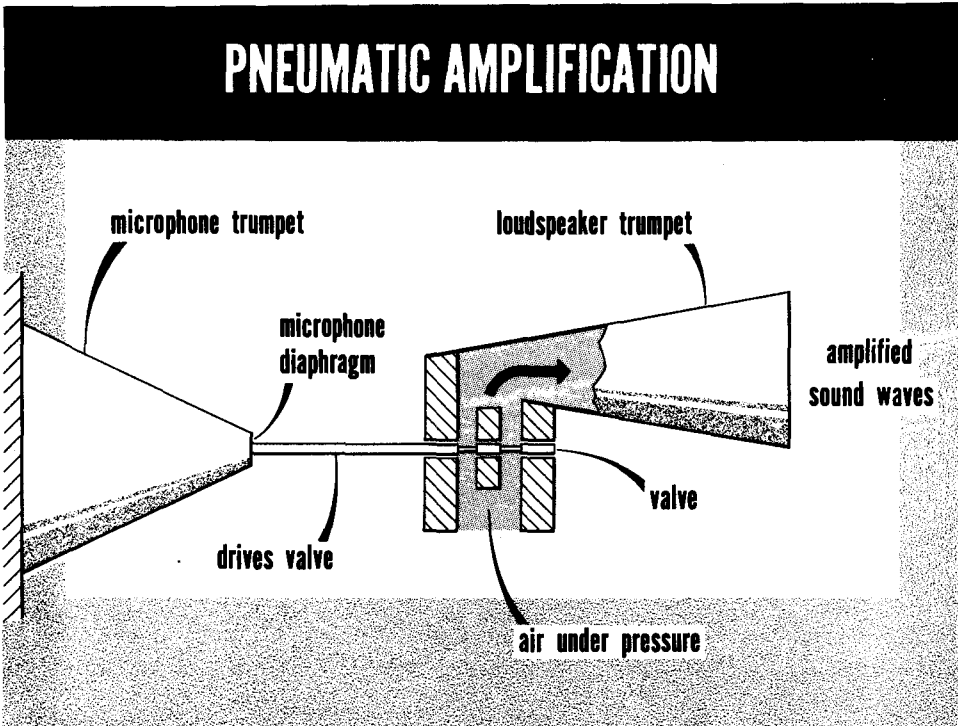

Nonetheless, this acoustic device had one thing in common with any real amplifier. Extra power had to come from somewhere. In that case it was air under pressure supplied from a suitable pump. In electrical amplification, extra electrical power is added and later converted to sound. Very small electrical impulses, or waves, put into an amplifier, control a larger amount of power taken from a battery, power line, or some suitable source and give a large amount of audio power to drive a loudspeaker or other transducer.

QUESTIONS AND PROBLEMS

1. What are the differences between echo and reverberation?
2. How does the standing wave pattern in a room or auditorium differ from that in an organ pipe?
3. Explain what causes sound waves to reflect when they encounter the surface of a different material.
4. When sound is reflected, is all of the wave reflected, or does some of it pass into the reflecting material?
5. What is the reverberation time of a building or auditorium?
6. What is the inverse-square law? Explain when it applies to sound waves.
7. What makes listening to anything outdoors different from listening to the same thing indoors?
8. Explain how the principle of masking applies (a) to trying to hear a conversation at a noisy airport, and (b) in getting the full benefit of listening to high fidelity.
9. Does wind stop sound waves? If not, why is it more difficult to hear any distance up-wind than down-wind?
10. Explain why you think a reproduction of violin playing through a loud-speaker with a metal horn would not sound very realistic.
11. What is the connection or relationship between frequency and wavelength in sound waves? What would be the wavelength corresponding to a note whose frequency is 250 cycles, if the speed of sound is 1100 feet per second?
12. Listening to a particular high fidelity setup, the following facts are noticed: (a) an organ note of 41 cycles is equally audible anywhere in the room; (b) a power-line hum (that proves to have a frequency of 180 cycles) seems quite strong in places and almost inaudible at others; (c) the sound of a snare drum played with a wire brush on a certain recording is audible in front of the loudspeaker, but not toward the sides of the speaker enclosure. Explain these differences.
13. What does the word transient mean, but to what is its meaning restricted (a) musically, (b) in audio?
14. Why do instruments or other sources of sound with "impact" transients (a) attract attention, and (b) give a good indication of their direction, which smooth-starting tones do not?
15. Why does a sound of particular intensity only seem to carry a certain distance? How can a megaphone help sound to carry further?
16. Do the following devices amplify sound: a megaphone; a speaking tube; the reflecting board over a speaker's platform? If so, why? If not, why not?

MICROPHONES

The Purpose of Microphones

Sound waves have to be converted into electrical impulses to be amplified. A microphone is needed to convert the tiny acoustic vibrations into electrical waves.

BASIC PARTS OF MICROPHONE

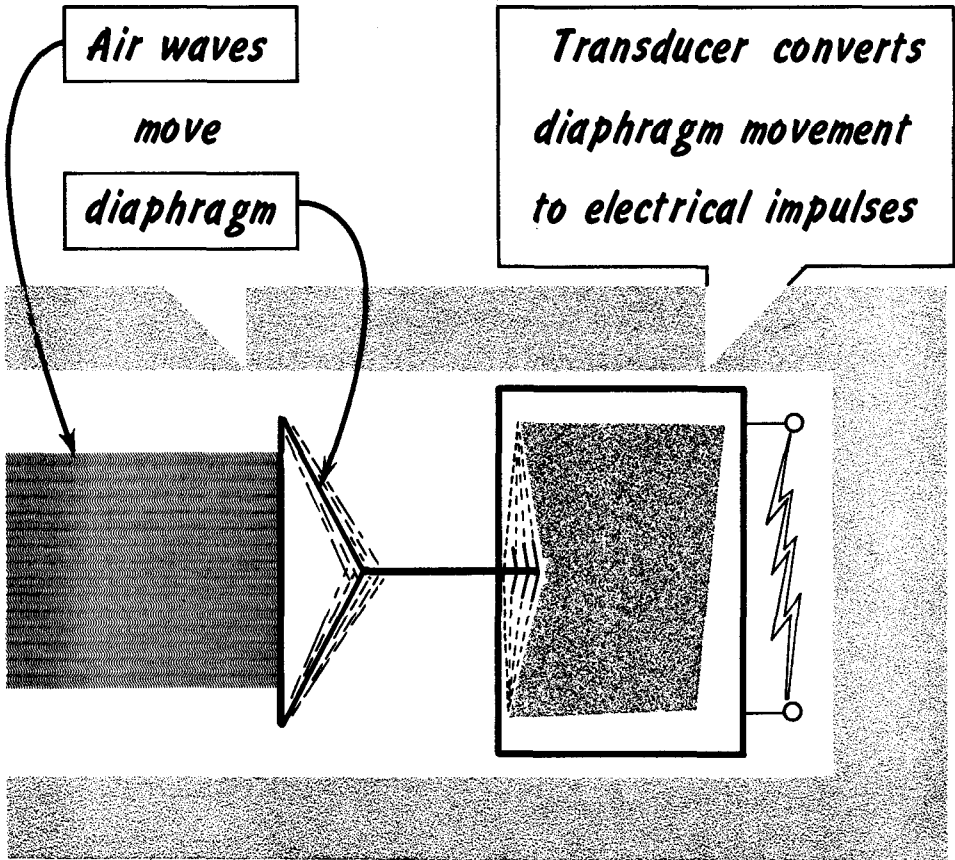

Every microphone has two basic actions: first to convert the acoustic vibrations of the air into mechanical vibrations by having the air move a diaphragm—a light stiff surface; second, it must act as a *transducer*, and convert this movement of the diaphragm into electrical currents or voltages. One important difference between microphones is the arrangement used for making this conversion.

MICROPHONES

The Dynamic (Moving-Coil) Microphone

THE PRINCIPLE OF DYNAMIC-MICROPHONE OPERATION

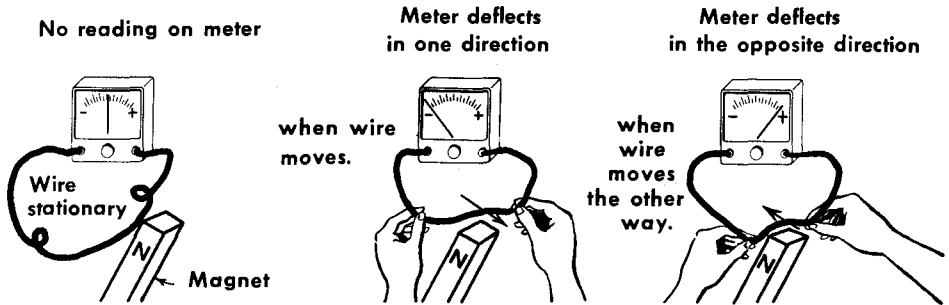

If a wire connected to a meter that will indicate when current flows is moved about near to a magnet, the meter will show current fluctuations. When the wire is *moved*, the meter deflects. Holding the wire still produces no current. The direction of current indicated on the meter depends on the direction in which the wire is moved. This is an ideal basis for converting movement into electrical current. Because *movement* is the essential feature for conversion, a microphone using this principle is called a *dynamic* microphone. The problem in making a microphone of this type is that a large movement is needed to produce even a small current, while the movement of the air particles due to sound waves is small.

INCREASING
THE
EFFECTIVENESS
OF THE
MAGNET

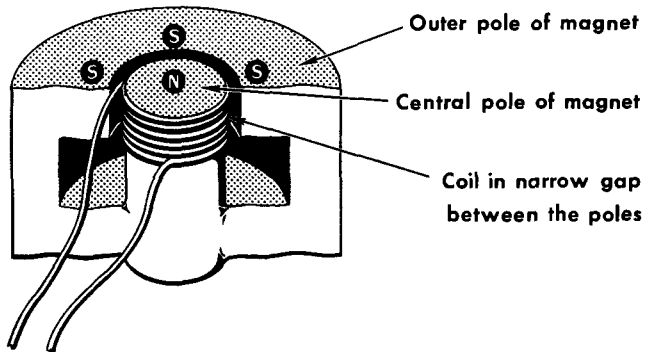

This problem is overcome, to some extent, by increasing the intensity of the magnetic field. A North and South pole are brought close together, and the wire moves in the narrow space between them. To increase its effectiveness, many turns of wire move in the same gap. It is convenient to make the gap circular, because this simplifies construction of the coil, gets the poles close together, and gives the coil free space in which to move.

MICROPHONES

The Dynamic (Moving-Coil) Microphone (contd.)

Converting movement into current is only part of the job. We must first move the coil by means of the sound waves, which requires a diaphragm. To move freely, the diaphragm must be light—as little heavier than air as possible. Because the coil is also attached to the diaphragm, it, also, must be as light as possible, or it would load the diaphragm down. Hence, a small coil must be used.

CROSS SECTION OF A SIMPLE MOVING-COIL MICROPHONE

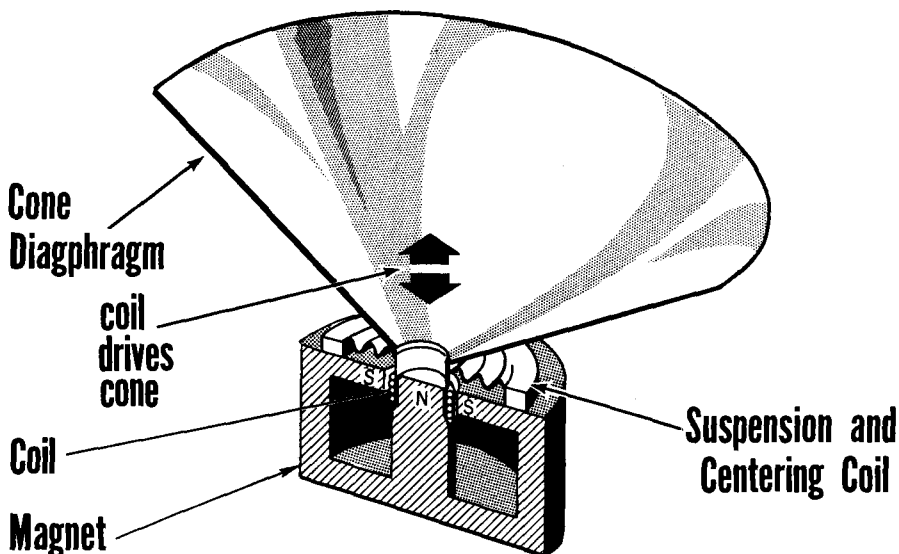

The use of a small coil requires a very intense magnetic field to get the best results. To accomplish this, the gap is made very small. To prevent the coil rubbing against the magnet poles, a centering "spider" or suspension is used, which allows free movement in the direction of vibration, while preventing the coil from moving against the pole faces.

MICROPHONES

The Velocity (Ribbon) Microphone

Another microphone that uses the same basic idea is the ribbon type. Instead of having a coil of wire, however, a single flat flexible ribbon of aluminum, or aluminum alloy, is used. It moves with the air vibrations, and the magnet poles on either side of it cause it to generate currents. The two basic microphone actions are thus served by the ribbon alone—it acts as both diaphragm and transducer.

BASIC CONSTRUCTION OF A RIBBON MICROPHONE

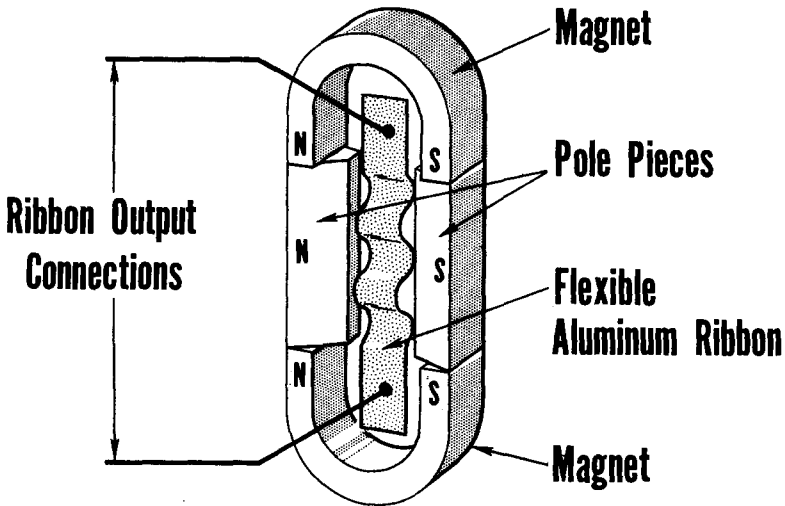

The ribbon microphone is also called the *velocity* type, because its response is proportional to the velocity of motion of the air particles in the sound wave rather than to pressure fluctuations. These microphones are also called *pressure-gradient* microphones because the movement of the ribbon is due to the pressure gradient—the difference in a pressure caused by the sound wave—between its back and its front. It is this constantly changing difference in pressure, of course, that controls the velocity at which the air particles move around the ribbon. Hence both “velocity” and “pressure gradient” are equally descriptive of the action of the ribbon microphone.

MICROPHONES

The Electrostatic (Condenser) Microphone

If an electrophorus (a simple instrument used in demonstrating the properties of electrical charges) is charged up and connected to an electrostatic voltmeter, a low reading will be obtained with the plates of the electrophorus in contact with each other. When the moveable plate of the electrophorus is lifted from its base, the reading will rise—probably shoot off the scale. When the plate is replaced, the reading will return to the earlier value.

The Principle of **CONDENSER MICROPHONE OPERATION**

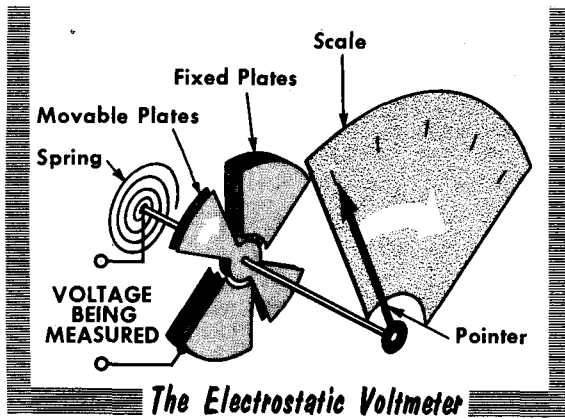

Low
reading

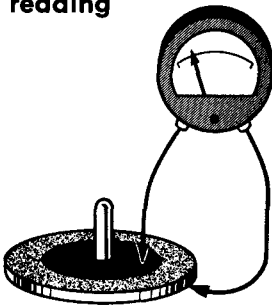

ELECTROPHORUS

reading
GOES UP

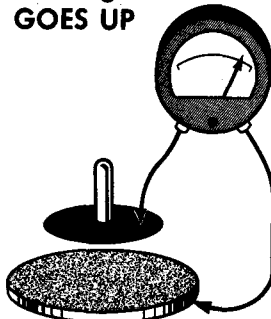

ELECTROPHORUS

Reading
RETURNS

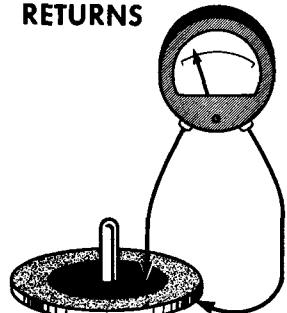

ELECTROPHORUS

This shows that when the distance between the charged plates changes, the voltage due to the charge changes. This principle is used in the electrostatic or condenser microphone. (Nowadays, the use of the term "condenser" is discouraged for most purposes—it should be *capacitor*, but most people still use the older term for the electrostatic microphone.)

MICROPHONES

The Electrostatic (Condenser) Microphone (contd.)

In a condenser microphone, one plate is flexible, whereas the other has holes in it that permit air to flow into the space between them. (This permits the flexible plate to move freely due to sound waves from either direction.) The motion of the flexible diaphragm changes the spacing between it and the fixed plate, and produces voltage fluctuations.

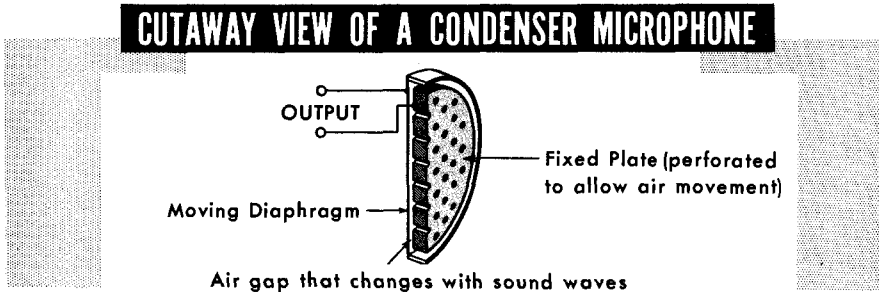

To make a condenser microphone work, it must have a steady electric charge upon it (obtained from a source of high voltage) that is isolated from the microphone so that a change in the spacing between the plates due to incident sound waves causes the voltage between them to go up and down. This is done by connecting a high voltage across the plates through a large resistance. The fluctuating voltage due to sound waves is fed through a coupling capacitor to an output resistor.

The capacitance of the coupling capacitor is greater than that between the microphone plates, and both the resistors are so large that the charges on capacitors do not have time to change during the slowest fluctuations due to sound waves. Because the charge on the coupling capacitor does not change, the voltage across it also must be constant. Therefore, the voltage that appears across the output resistor has the same fluctuations put out by the microphone, without, however, the polarizing voltage applied to microphone plates.

CONDENSER MICROPHONE CIRCUIT

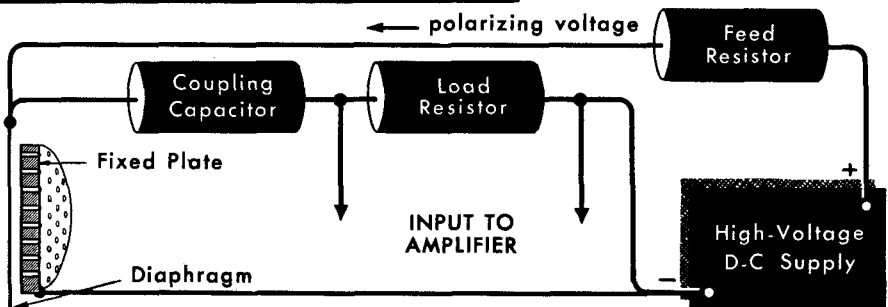

MICROPHONES

The Crystal Microphone

HOW A PIEZOELECTRIC CRYSTAL WORKS

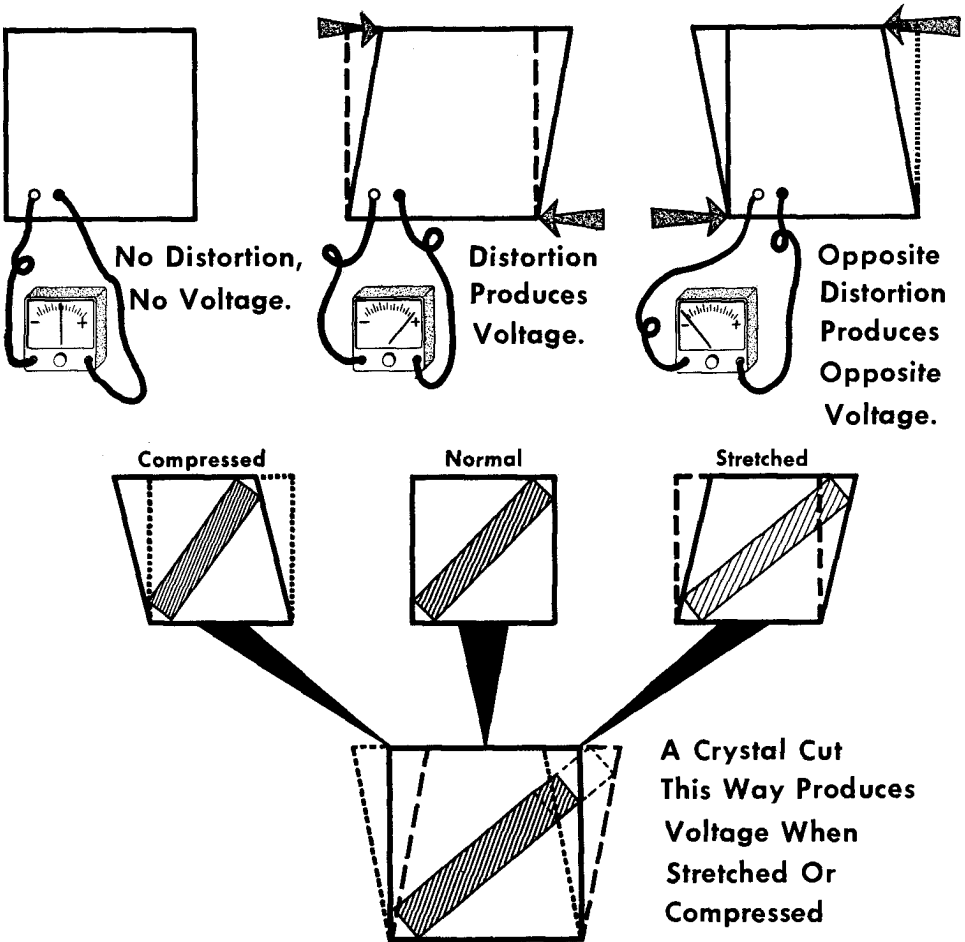

A *piezoelectric* crystal is another kind of transducer. When such a crystal is put under mechanical strain, a voltage is set up inside the crystal structure. (Similarly, when a voltage is applied to the crystal, mechanical bending occurs—this makes the crystal useful for loudspeaker use.) The best or most efficient method of getting a voltage from a crystal is by changing its shape. By cutting pieces of it in a particular manner, the crystal can be made to produce its best voltage by stretching or compressing.

MICROPHONES

The Crystal Microphone (contd.)

Even this type of cutting does not make an efficient transducer, because the amount of force needed to produce any voltage is great and the force imparted by sound waves is small. The action can be improved by cementing two crystals together, so that when one is compressed and the other is stretched, the voltage between surfaces adds up in the same direction. Bending this combination gives increased output for a smaller applied force.

The Bending Crystal Used in a Microphone

If two crystals are cemented together,

BENDING stretches one crystal
and compresses the other.

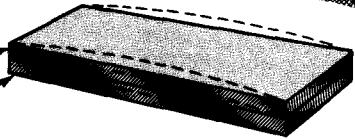

The cuts are opposite and the output voltages add.

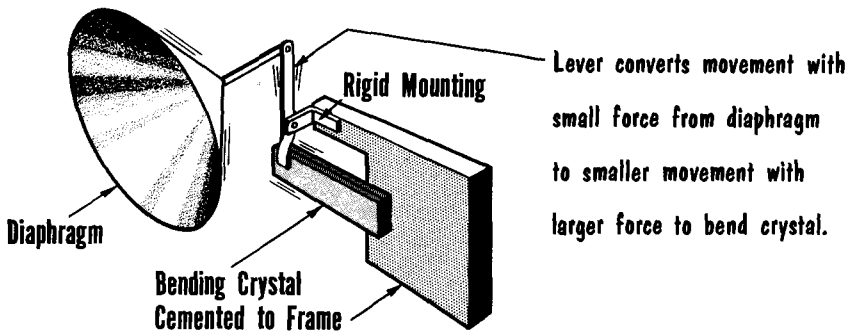

This double crystal is still much too stiff for use as a microphone. For this reason, the diaphragm is coupled to the crystal by a lever action, which transforms a larger movement with smaller force to a smaller movement with a larger force at the crystal. In this way, the tiny movements of air particles in contact with the diaphragm are efficiently coupled to the crystal element to produce as sensitive a microphone as any other.

MICROPHONES

The Carbon Microphone

There is still another kind of microphone in common use; in fact, the carbon microphone forms the basis of millions of telephone instruments in use today. Any loose contact can be susceptible to vibrations around it that will alter its effectiveness in sympathy with the vibrations. A single loose contact, however, makes a poor microphone—all it can do is make noises that keep time with the speech or music. (It is, for example, suitable for relaying the ticking of a watch.)

The Principle of Operation of The Contact Microphone and

HEADPHONES

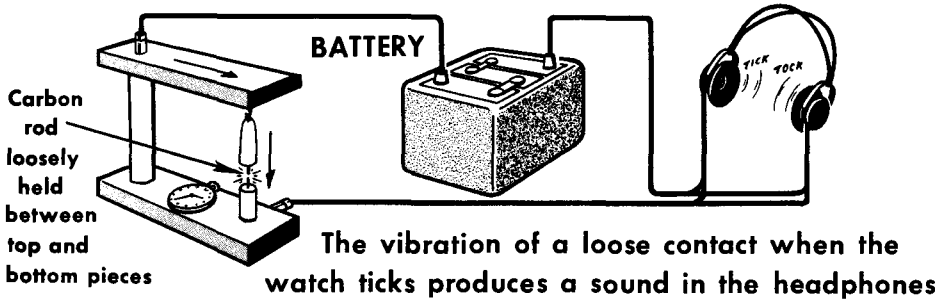

the Carbon Microphone

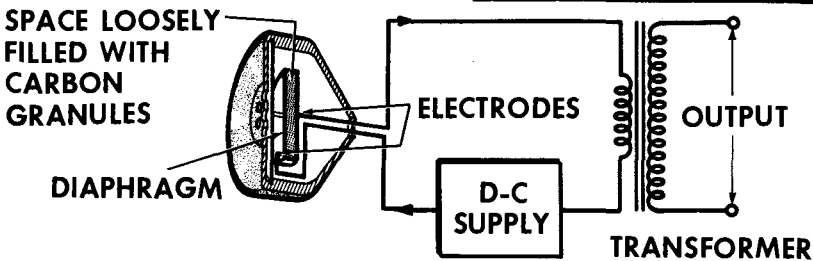

A carbon microphone extends this principle by using thousands of very small loose contacts. The space behind the diaphragm is loosely filled with tiny carbon granules. When the diaphragm vibrates due to sound waves reaching it, the granules are agitated. Because of the large number of contacts, the overall resistance of the microphone through the granules averages out in such a way that it follows the waveform of the sound striking the diaphragm. When a steady source of voltage is applied to the microphone, the current passed through it will fluctuate in sympathy with the sound waves.

MICROPHONES

Microphone Directivity

THE VELOCITY MICROPHONE responds equally to sound waves from the Front and the Back,



Top View of Microphone

but not at all to sound waves from the side.

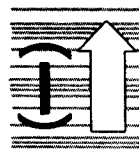

Side

It therefore IS BIDIRECTIONAL

As well as differing between the way that they convert vibrations into electrical voltages or currents, microphones differ in the way that they pick up acoustic waves. For example, the ribbon moves with the air particles as the wave passes it. If a wave passes in a direction parallel to the flat surface of the ribbon, the ribbon will not move, and no sound will be picked up. This property of a ribbon microphone makes it *bidirectional*. This means it is sensitive to sound from two directions (back and front), but not sensitive to sound from other directions.

In most other types of microphones, the back of the diaphragm is shut off from access to outside air, so that sound waves reach it only from the front. This means that the microphone is sensitive only to pressure fluctuations, rather than to a pressure gradient or the air particle velocity. For this reason, such microphones are called *pressure type*. The pressure at the diaphragm varies in the same way, regardless of the direction from which the sound comes. For this reason, pressure microphones pick up sound from all directions, and are called *omnidirectional*.

THE PRESSURE MICROPHONE responds equally to sound waves from

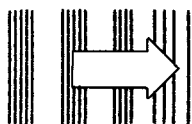

the Front,

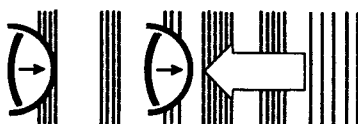

the Back,

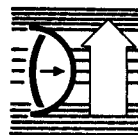

and the Side.

It therefore IS OMNIDIRECTIONAL

MICROPHONES

Microphone Directivity (contd.)

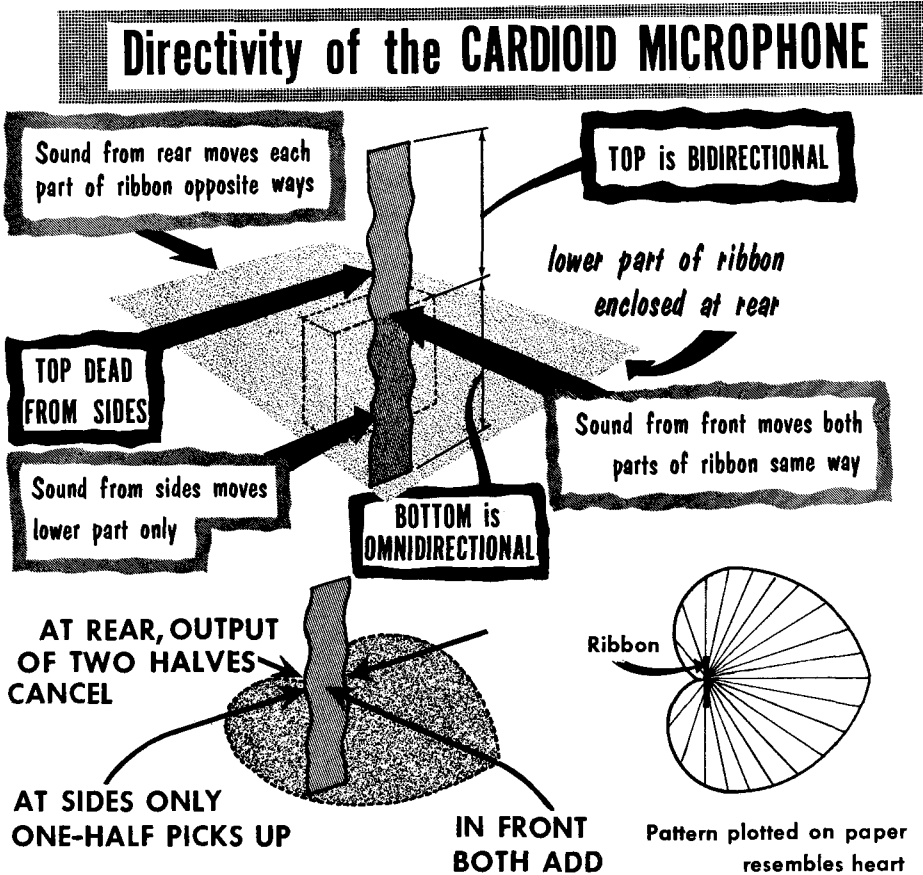

Suppose that the lower half of a ribbon microphone is enclosed at the back so that this portion works like a pressure microphone; when sound comes from the front, both halves will move the same way and the microphone will give maximum output. Sounds from the back, however, will move the two halves of the ribbon in opposite directions, so that the resultant output cancels. Sound from the sides will only move the half of the ribbon that is enclosed at the back, but not the free, or velocity, half. This makes what is called a *unidirectional* or *cardioid* response.

Unidirectional signifies pickup from only one direction—the front. Cardioid describes the heart-shaped sensitivity of this microphone, when plotted on polar-coordinate paper. (To plot this kind of curve, the output from the microphone for a given sound intensity from various directions is marked along radii with corresponding directions.)

MICROPHONES

Microphone Sensitivity

A microphone does not amplify sound. The intensity of the waves is very small, whether the diaphragm is arranged to pick up particle movements, as in the ribbon type, or pressure fluctuations. The regular telephone microphone, which is of the carbon type, is effective only for two reasons:

1. It is provided with a mouthpiece to collect all the sound from the mouth of the person speaking into it.
2. It really works by "modulating" an electric current, *not generating one*. The current comes from a battery at the telephone exchange, and the vibrations of the diaphragm modulate this rather large current instead of generating small ones from the vibrations themselves.

At the receiving end, too, advantage is taken of an earphone to get all the received sound energy right into the listener's ear. (The output of a telephone receiver is not great enough to drive a loudspeaker.)

The Carbon Microphone modulates an electric current

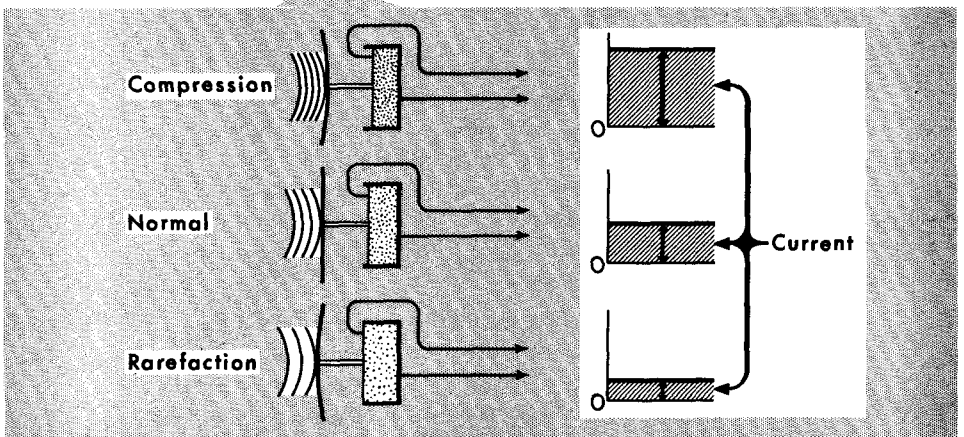
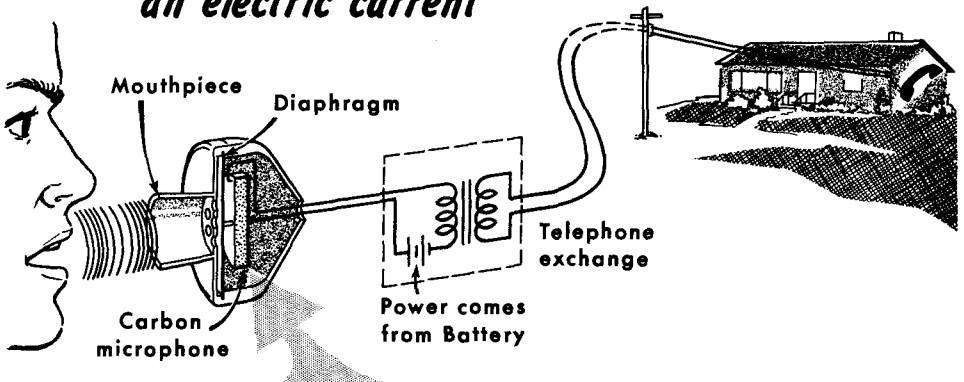

MICROPHONES

Microphone Sensitivity (contd.)

A small loudspeaker can be used to make a microphone that is quite sensitive by ordinary standards. Sound waves impinging on the speaker cone move the voice coil and generate small currents. This type of microphone does not give as good quality as a properly designed one, but it is often used in intercommunication sets of the kind used in offices. If you try connecting two small loudspeakers in different rooms, you will only be able to hear by having someone speak very close to the "microphone" and putting your ear very close to the other loudspeaker.

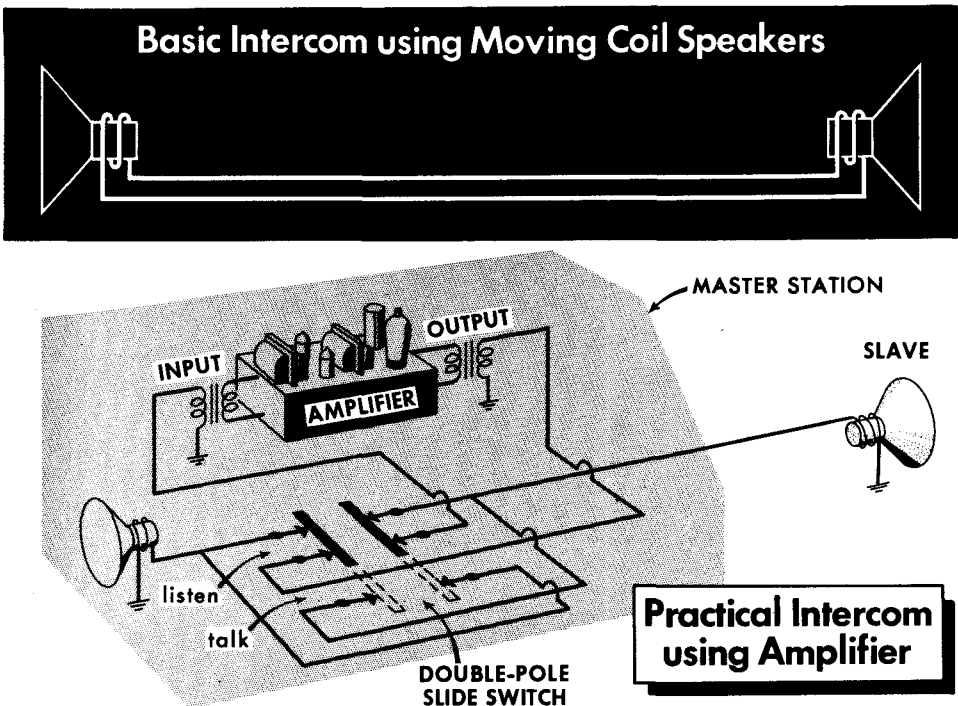

Practical intercommunication sets use an amplifier, between the two speakers, which makes communication much easier. Even then the quality is not good, but has the well-known shrillness associated with such "squawk boxes." The reason for their use is that they are much more sensitive than any other form of microphone, and so make the system less expensive, by requiring less amplification and less attention to special wiring. (If a loudspeaker were connected directly to a moving-coil *microphone*, it would be virtually impossible to hear anything, however close the speaker was to the microphone and the listener to the loudspeaker.) Thus, any practical form of microphone needs electrical (or, more properly, *electronic*) amplification, to get enough current to be of any use in driving a loudspeaker.

MICROPHONES

The Microphone Matching Transformer

A moving-coil or ribbon microphone directly converts acoustic power into electrical power; however, there is very little power to use, and the microphone must make the best use of what there is. (Electrical power is measured in watts, found by multiplying current in amperes by potential difference in volts; for microphones, the output is in fractions of a *microwatt*.)

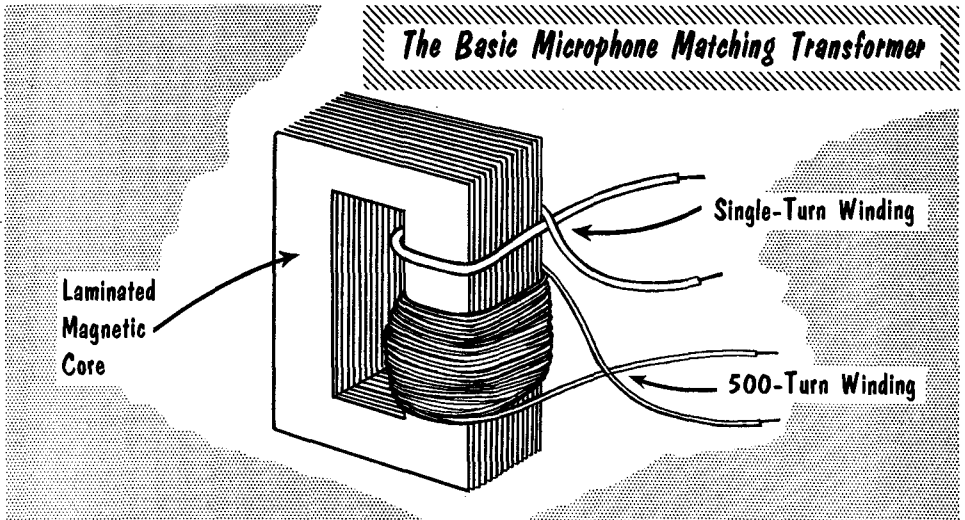

In the moving-coil microphone, there may be as many as 100 turns in the coil, each of which generates 5 microvolts for a particular sound intensity. The whole coil, therefore, gives a total of (100×5) or 500 microvolts. A ribbon does not generate much more than about 1 microvolt (open circuit) because there is not even one whole turn, and the magnetic field cannot be so intense, because of the wider spacing between the poles. However, the resistance of the ribbon is very small, about .05 ohm. Applying Ohm's law, we find that the short circuit current in the ribbon that would flow due to 1 microvolt is about $1/.05$ or 20 microamperes. The voltage output of the microphone can be raised by a microphone transformer, which has a small number of turns in one winding, and a larger number of turns on another winding, both wrapped round the same magnetic core.

In a transformer, every one of the turns will have the same voltage "generated" in it; if the single-turn winding generates 1 microvolt, all the other turns will also give 1 microvolt, and a 500-turn winding will give 500 microvolts. The total power will, of course, be the same, and with 20 microamperes available from the microphone into the 1-turn, the 500-turn winding will only give $20/500$ or .04 microampere. What the transformer does, in effect, is to replace the actual single ribbon with the equivalent of 500 very much thinner and lighter ribbons, all connected in series.

MICROPHONES

Microphone Impedance

In most electrical circuits, impedance, or resistance, refers to the relationship between voltage and current flowing in some component. This is easy to measure because the voltage source is *external* and the current *through* the components can be measured.

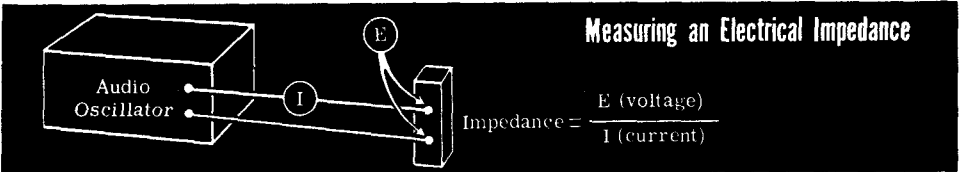

In a microphone, the voltage source is internal or *inside* the component, so that we cannot measure it separately. But we can measure the open-circuit voltage and then measure current when we short-circuit the microphone, so that there is no voltage. The relationship between this voltage and current is the impedance of the microphone.

Going back to the theoretical case of the previous page: without the matching transformer, the open-circuit voltage was 1 microvolt, while the short-circuit current, determined by the resistance of .05 ohm, is 20 microamperes.

In the transformer secondary, the open-circuit voltage is 500 microvolts, while the short-circuit current is .04 microampere. Therefore the effective impedance on the transformer secondary is 500/.04 or 12,500 ohms. This is the impedance the microphone presents on the transformer secondary.

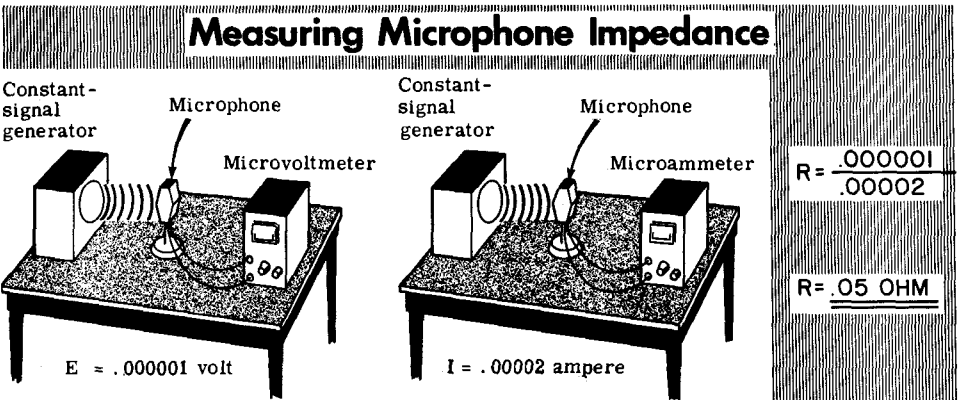

Thus the real impedance of .05 ohm has been multiplied by 12,500 .05, or 250,000. The impedance matching ratio 250,000:1 is the square of the turns ratio ($500 \times 500 = 250,000$).

QUESTIONS AND PROBLEMS

1. Why is a microphone needed in an electrical amplifying system, and what are its two basic actions?
2. What is the essential feature of a dynamic microphone? Indicate which of the following types can be called dynamic: moving-coil, ribbon, condenser, crystal, carbon.
3. Explain the reason for the construction of a moving-coil microphone with special reference to (a) the shape of the magnet, (b) the shape of the coil, (c) the requirements of the diaphragm.
4. All the following designations may correctly be applied to the same microphone; however, some of them may also be applied to other types to which the remaining designations are not applicable: dynamic, ribbon, bidirectional, velocity, pressure gradient; explain these differences.
5. What feature do the ribbon and condenser type microphones share in common? In what respects do they differ?
6. What operation similarity is there between a condenser microphone and a carbon microphone?
7. How does a crystal microphone work, and what steps are taken to make its sensitivity comparable with that of other types?
8. What are the three basic directional characteristics of microphones?
9. What is meant by (a) pressure and (b) velocity microphones? Do these methods of operation have any connection with directional pattern? If so, into which group would you classify a cardioid pattern?
10. If someone asked for a "directional" microphone, what types could be intended? Explain.
11. Give two reasons why the type of microphone used for telephones does not need electrical amplification.
12. Would you expect a small moving-coil loudspeaker to make a good or bad microphone? Explain.
13. Why does any high-quality microphone need amplification?
14. When a ribbon microphone whose resistance is .05 ohm is used with a 500:1 step-up transformer, it produces 500 times the voltage output for a given sound wave. What is the effective resistance of the equivalent microphone with its transformer?

LOUDSPEAKERS

The Purpose of Loudspeakers

Amplifying the currents from the microphone is not enough—we cannot hear currents! (Birds do *not* sit on telephone wires to listen to the conversations.)

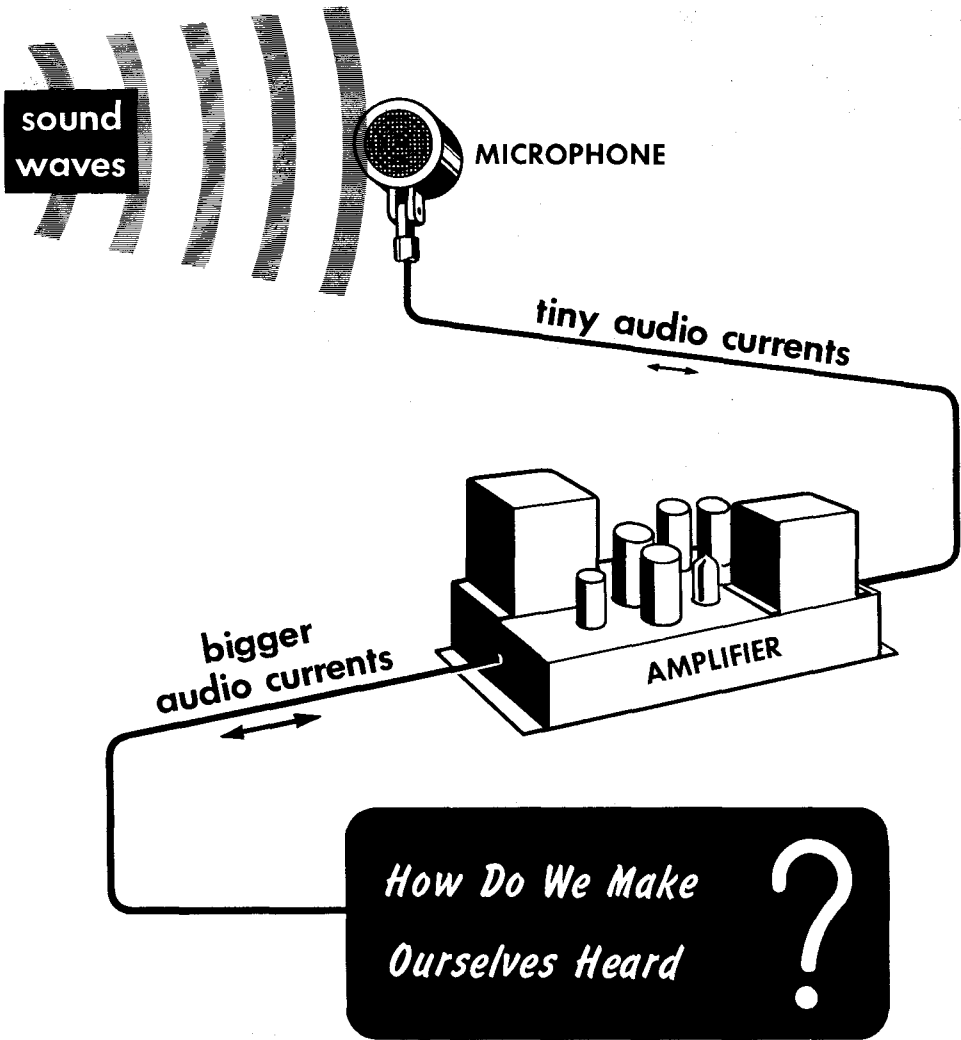

It is the purpose of loudspeakers to convert the varying currents back into sound waves. In fact, loudspeakers may be thought of as microphones in reverse. An example of the use of an actual speaker as a microphone was given earlier, and the principles of operation of the microphones already discussed are all used in making loudspeakers.

LOUDSPEAKERS

The Moving-Iron Speaker

THE PRINCIPLE OF MOVING-IRON SPEAKER OPERATION

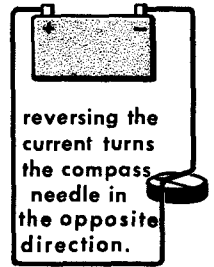
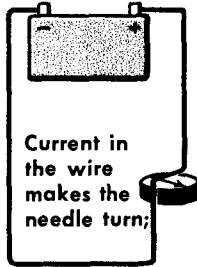

If you suspend a magnet or a compass needle over a wire connected to a battery, the needle will swing to one side. If you reverse the current in the wire, the magnet (or needle) will swing in the opposite direction.

The force given by the current in this setup is feeble—we could never produce appreciable sound output by passing the fluctuating sound currents through the wire (after attaching a diaphragm to the magnet). We can increase the force by using a stronger magnet, coiling the wire into many turns, and shaping the magnet so as to concentrate the effect of the coil. A strong magnet, however, must be heavy, and it would have difficulty moving at the speed of sound vibrations. For this reason, a large coil is used to provide the magnetism, but only a small piece of magnetic material (iron) is used to move the speaker cone.

In the early days of radio, thousands, if not millions, of these loudspeakers were made. Because of their construction, however, they could not respond very well to the wide range of frequencies used in sound, from the lowest tone given by an organ or other musical instruments—about 32 vibrations per second—to the highest overtone or harmonic required to give the correct “character” to sound. The iron or steel armature, moved by the currents, was too stiff to move freely enough at low frequencies and too heavy to move as rapidly as needed at high frequencies, hence the extreme frequencies did not get reproduced satisfactorily.

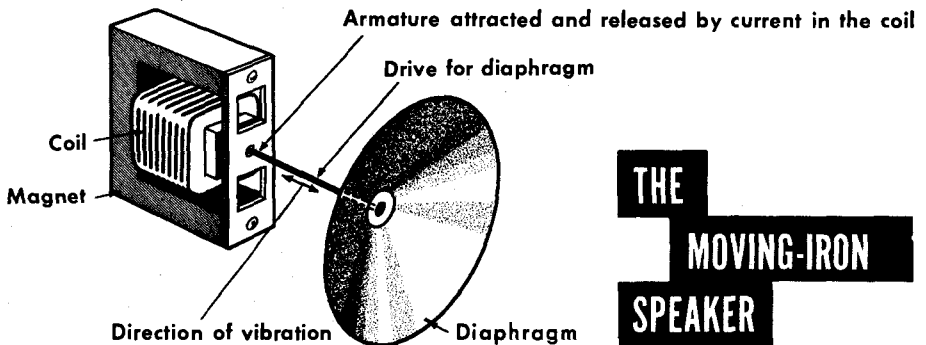

THE MOVING-IRON SPEAKER

LOUDSPEAKERS

The Moving-Coil Speaker

The *moving-coil* speaker was designed to overcome these defects. The magnet can now be as big and heavy as we choose, because it does not have to move. The coil is small and light, and is suspended by a light flexible material that will allow free movement at all frequencies. This makes a much better loudspeaker.

Parts of A DYNAMIC LOUDSPEAKER

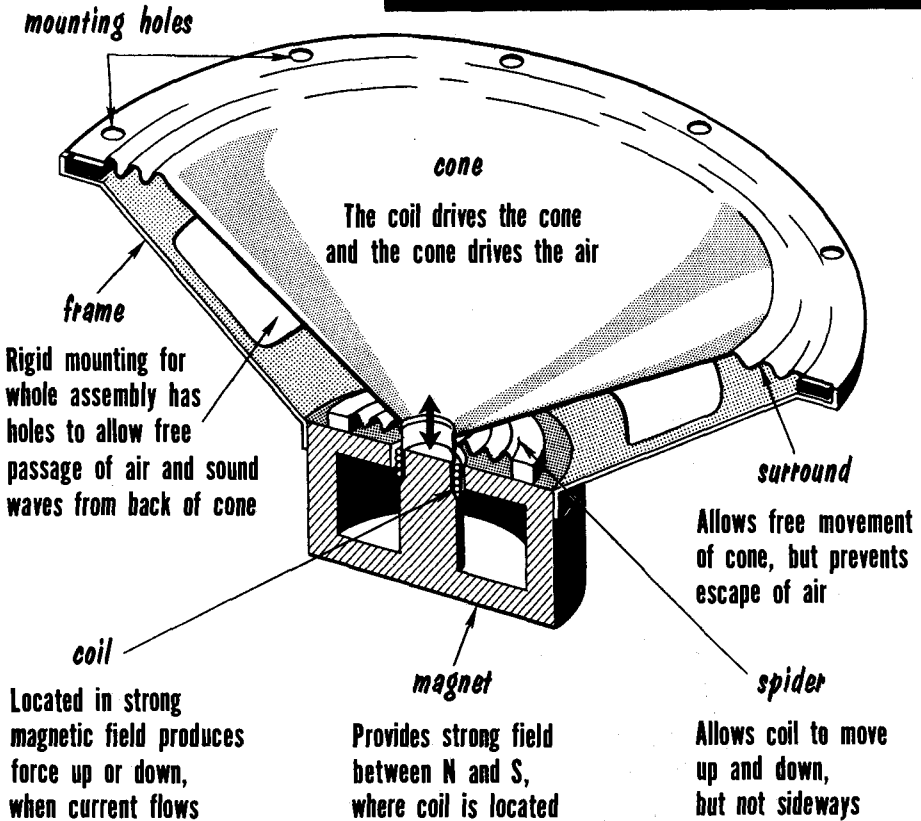

But why was the coil made round, or cylindrical? The requirements for getting maximum force to drive the cone (or diaphragm) are a strong magnetic field, and as much length of wire as possible in the field. The narrow cylindrical air gap permits a strong field that is easy to create. The attraction between the poles is uniform at all points, hence the center pole does not try to get out of position due to magnetic pull. By winding a thin, flat, cylindrical coil to work in this gap, the coil is kept light in weight, with maximum strength in the direction needed for drive.

LOUDSPEAKERS

The Speaker Diaphragm

Why the Speaker Diaphragm is a Cone

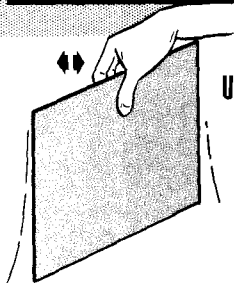

Using a flat sheet is ineffective because it buckles.

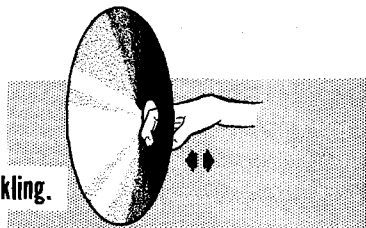

Using a cone drives the air without buckling.

Next, why the shape of the diaphragm—a cone? Again the requirement of rigidity with lightness of weight. Try waving a piece of cardboard or paper in a large sheet, and you will find it is impossible to move any air rapidly back and forth—wherever you hold the paper or card. But take a cone of paper and hold it by the center, where the coil drives a loudspeaker cone, and you will be able to push air back and forth with it much more easily, although it is just as light, as the flat sheet. The conical shape gives rigidity.

But how big should the cone be? This depends on the wavelength of the sounds we want to make. If the size of the diaphragm is smaller than a wavelength, the air tends to run round the edges instead of going back and forth with the diaphragm. If the diaphragm is large compared to the wavelength, the air will not have time to dodge around it during the passage of each wave.

Cone Size and Frequency

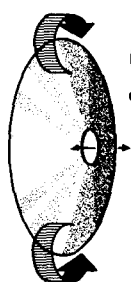

AT LOW FREQUENCIES
(long wavelengths), air
escapes around the edges.

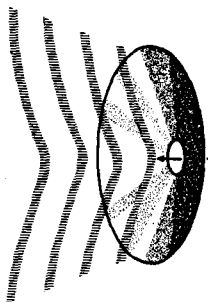

AT HIGHER FREQUENCIES
(short wavelengths), air
does not have time to
escape and the sound
waves are pushed out.

LOUDSPEAKERS

The Speaker Diaphragm (contd.)

Wavelength varies inversely with frequency. The low-frequency tones have long wavelengths, whereas the high-frequency tones have short wavelengths. This means that we need a large diaphragm for the lower frequencies, while a smaller one will serve for the high frequencies. Of course, a large diaphragm will also move air at the higher frequencies, unless it is too heavy to be driven effectively at the higher speeds. For this reason, many installations use two or more speakers of different sizes, each of which handles only the band of frequencies that it serves best: large speakers (woofers) for the low frequencies, medium-sized speakers (squawkers) for the mid-range, and small speakers (tweeters) for the high frequencies.

Because of the "size" of the wave at low frequencies, a diaphragm has to move a lot of air to make sound. If you look at a loudspeaker diaphragm, you will see that it moves quite a long way for the low frequencies, although at higher frequencies, it radiates sound without visible movement. At these higher frequencies, however, the air load on the diaphragm is so great that the voice coil can hardly move. The high frequencies thus are not radiated.

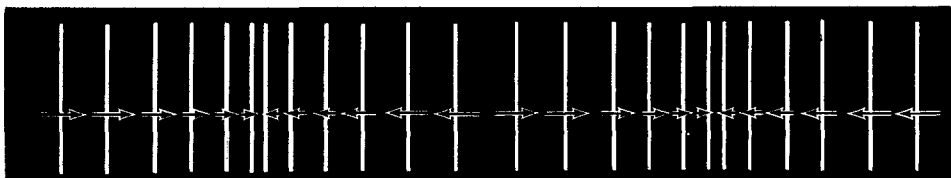

At low frequencies (long wavelengths), large volumes of air are compressed and expanded, requiring large air movement.



At high frequencies (short wavelengths), small quantities of air move small distances.

The reason for this difference in movement can best be understood by thinking of wavelengths. To create a pressure change, air has to be pressed into a given space. When the wavelength is small (as at high frequencies), the space momentarily requiring the additional air is small, and the pressure can be increased by very small (but very rapid) air movement. When the wavelength is large, the area of increased or reduced pressure is large and requires the movement of a bigger mass of air to achieve it.

BAFFLES

The Use of a Baffle

To avoid air escaping round the edges, the diaphragm should be at least one-half a wavelength across. If we want to radiate a frequency of 32 cycles, for which the wavelength is $1100/32$ or about 34 feet, the diaphragm would need to be about 17 feet in diameter. One way of avoiding this awkward size is to mount the loudspeaker in a baffle.

MOUNTING THE LOUDSPEAKER IN A BAFFLE BOARD

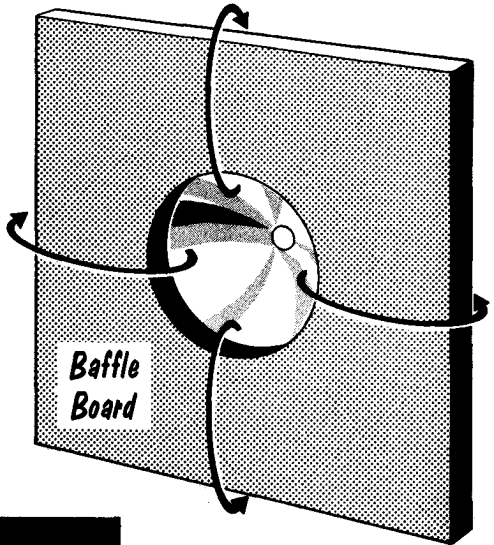
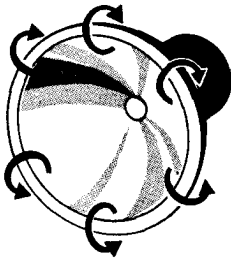

REDUCES ESCAPE AROUND EDGES

The loudspeaker diaphragm is continued by being joined to a solid, fixed board that extends out to the required size. This stops the air from escaping around the edges. Of course the diaphragm will have to move further to get the same amount of air movement than would one the full size of the baffle, because only a fraction of the surface is moving. But preventing the air from escaping around the edges of the diaphragm will also prevent the diaphragm from moving without radiating a wave at all. The situation is thus much better than without the baffle. Of course, a smaller baffle will do the same thing, except that it will not be effective to such a low frequency.

BAFFLES

The Infinite Baffle

Next we consider ways to "tidy up" the baffle. A big board suspended in space, with a loudspeaker mounted in a hole at its middle, is not an ideal piece of furniture. And unless it is very big, it still has limitations in low-frequency response. Of course, if the baffle could be made infinitely large, by extending it up to the sky, it would be perfect, but this is obviously not practical.

The purpose of an infinite baffle is to prevent any access from back to front around the edges. Putting the loudspeaker in a box that is completely closed except for a hole for the diaphragm does the same thing. This works perfectly, as far as enabling the diaphragm to radiate frequencies right down to the lowest is concerned. However, this arrangement gives the diaphragm two jobs to do; as well as radiating sound from the front, it must alternately compress and rarefy the air inside the box.

The air in front of the diaphragm moves much more readily than that behind it (which is restricted by being contained in the sealed box). For this reason, the air in the box places a greater "loading" on the diaphragm movement, and only a fraction of the driving force produced by the voice coil is used to radiate sound from the front; most of the energy is wasted compressing and rarefying the air inside the box. The smaller the box, the bigger the waste, and the less efficient the complete assembly is as a loudspeaker.

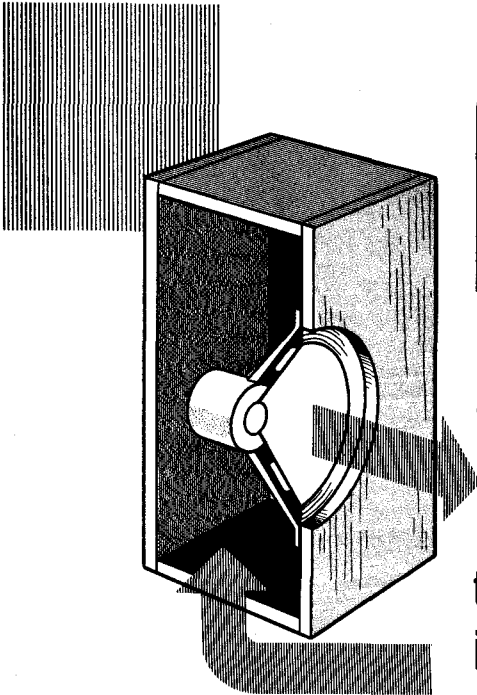

*In the Box-type Baffle
the Cone Has Two Jobs
To Do*

to push sound waves out front

and

to compress and expand air
inside box

BAFFLES

The Bass-Reflex Baffle

Two main facts bothered loudspeaker designers:

1. To get any radiation of power at low frequencies, the diaphragm has to move a lot of air.
2. The diaphragm moves air on both sides of it—so it would be an advantage to use *both* sides. The movements are, however, *in opposition*; the front pushes when the back pulls, and vice versa.

If only the movement from the back could be “turned around!” This is just what the bass-reflex does.

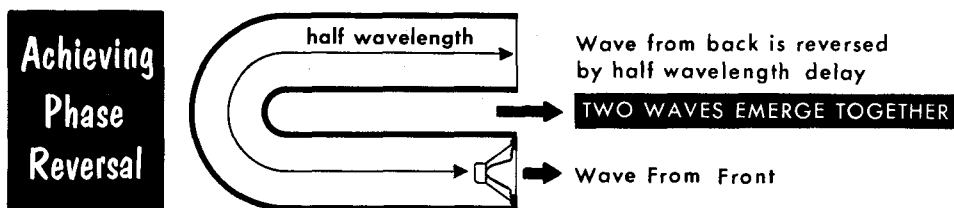

In normal propagation of sound, the only way to get the waves from the back turned around would be to take them for a half-wavelength longer journey than the waves from the front. To reproduce 50 cycles per second, this requires a propagation path of eleven feet, which can hardly be contained in a livingroom piece of furniture.

When sound travels through air, the wave maintains natural relationships between the pressure fluctuations and particle movements, because the air is free to move and allows the wave to develop. When air is confined in a space or an opening, however, the natural relationship no longer exists. Air in the mouth of the box is free to *move*; so it will not compress, but moves freely. When air at the mouth moves in and out, the air inside the box *compresses* and *rarefies*, but it does not move much. Hence (*relatively speaking*), the air in its mouth moves without appreciable changes in pressure; the air inside the box changes pressure without appreciable movement. Of course, there is no definite line where the air changes from one condition to the other, but most of the air associated with the box is in either one condition or the other.

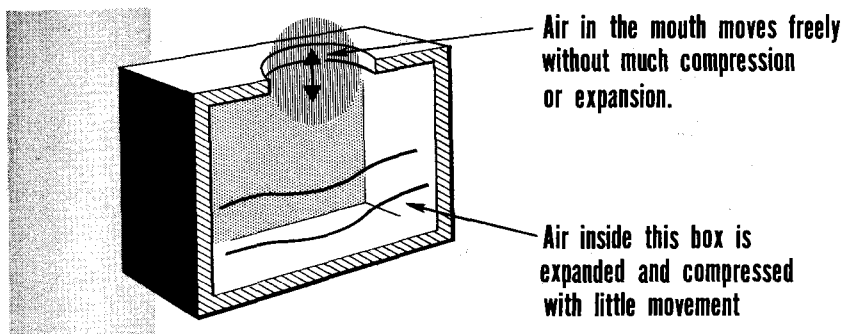

BAFFLES

The Bass-Reflex Baffle (contd.)

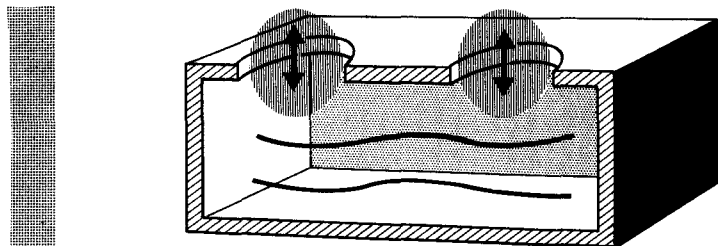

In a box with two holes, the air in the holes moves together

Achieving In-phase Action

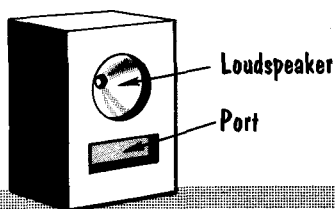

*To Make
The Practical
Bass-Reflex
Baffle*

When a box has two openings of the same size, the fact we just discussed means that air movement in both mouths must be approximately *in-phase*. The air inside the box does not move much, but only compresses and rarefies, whereas that in the mouths moves without compressing and rarefying appreciably. If the air in the mouths did not move in and out at the same time, there would have to be considerable air movement inside the box which does not occur. It is easier, particularly at the resonant frequency of the box, for air to move with both mouths working together, or *in-phase*.

In a bass-reflex cabinet, or *enclosure* as it is called, one of the mouths is occupied with the loudspeaker diaphragm, which drives the air in that mouth, whereas the other is just an open "*port*." The dimensions of the second mouth, or port, are adjusted so that the air in the port is about equal in weight to the total of the diaphragm and the air it moves. This provides the correct condition for the two waves to emerge in phase at the resonant frequency of the box. The frequency is lower than could be obtained with the so-called infinite baffle of the same size, and helps radiate sound energy from both back and front of the diaphragm, without cancellation.

At higher frequencies, the box does not act in this way, but absorbs the movement from the diaphragm in the volume of air inside the box, without moving the air in the port mouth appreciably. Hence, at these frequencies, this arrangement works in the same way as the infinite baffle.

HORNS

The Use of a Horn

The best diaphragm- or cone-type loudspeaker is a very inefficient transducer: only a small part of the electrical power delivered to it is converted into sound waves. An average efficiency figure for modern units is about 10%; a poor one may be 5% efficient or less; a good one may reach 20%. Thus even the best throws away four-fifths of the power that it gets. The main reason for this inefficiency is the difference in the density of the material of which the diaphragm is made and that of the air. Because of this big difference, the voice coil spends much more of its driving force moving the diaphragm than the air in contact with the diaphragm.

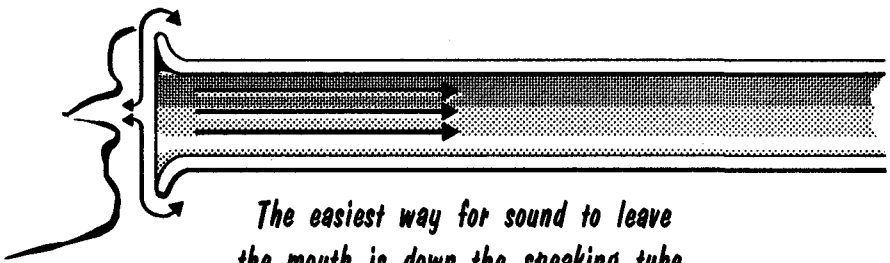

The easiest way for sound to leave the mouth is down the speaking tube

**A HORN
IMPROVES
ACOUSTIC
EFFICIENCY**

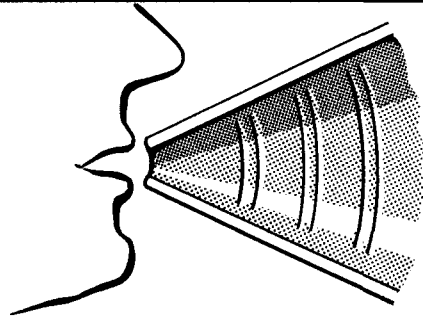

As well as directing sound, the megaphone--like the speaking tube--saves vocal effort by preventing unnecessary escape.

Using a *horn* is a way to improve this situation. The method by which a horn improves acoustic efficiency can be illustrated by two devices: a speaking tube and a megaphone. In a speaking tube, sound is propagated without the wave being allowed to expand. For this reason, the intensity does not fall off according to the inverse-square law, but reaches the other end of the tube almost undiminished.

HORNS

The Use of a Horn (contd.)

The megaphone, in addition to concentrating the sound into a narrower angle, intensifies the sound in that angle. Without the megaphone, sound comes from the mouth in a sudden transition from a narrow aperture (the mouth) to "free" space. The megaphone, by tapering off this transition, enables the mouth to radiate more sound with less effort.

To transmit a certain amount of air or sound wave through a small hole requires the air to be forced further (and harder) than in a large hole

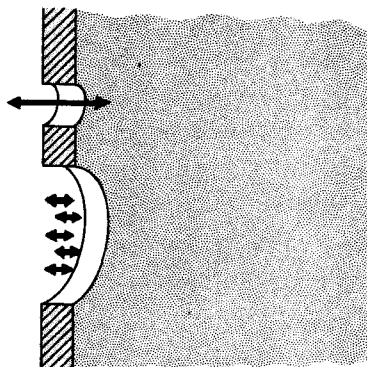

Putting a diaphragm over a smaller hole increases the effort to move the air and reduces diaphragm movement, improving efficiency in converting voice-coil force to air movement

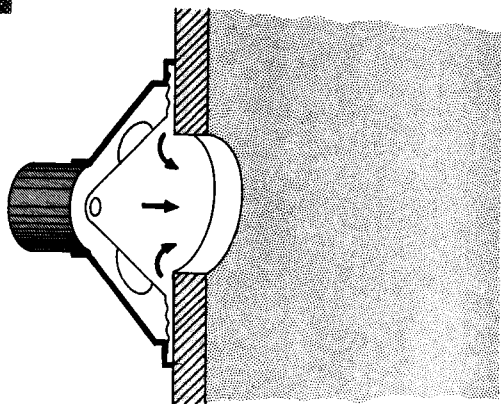

It requires more force to move air in a narrow channel than it does in a wider channel, because individual air particles in the narrow channel have to move farther to allow the same quantity, or volume movement. For this reason, placing a diaphragm opposite a channel that is smaller in cross section area will enable the voice coil to spend more of its energy in driving the air, wasting less in driving the diaphragm. This is like putting a speaking tube to the diaphragm. If we couple the tube to a megaphone, we shall have a more efficient sound radiator than the diaphragm by itself. The narrow opening makes the diaphragm move more air, and the megaphone effects a transition more gradually, so that this greater movement is used, instead of being lost.

HORNS

Horn Shapes

A horn thus serves two purposes: it confines the sound into a narrower angle, but, more important than this, it improves acoustic efficiency by preventing the losses that occur at sudden transitions. This improvement in efficiency is sometimes the only reason that a horn is used, since some horns are designed to distribute sound in all directions.

Expansion in Conical Horn

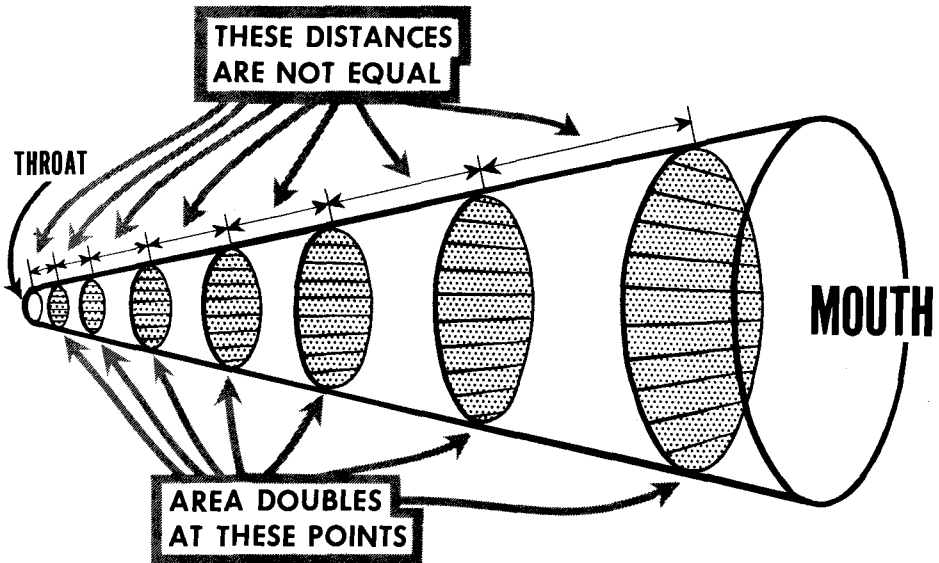

Area inside a cone-shaped horn does not double at constant changes in distance along the cone. Therefore the sound waves do not expand at a constant rate.

The megaphone is a straight-sided cone, because this happens to be a convenient way to make it. Although it does improve acoustic efficiency, other shapes will do so even better. The purpose of a horn is to “stretch” the developing wave gradually. (The wave should not expand too rapidly suddenly, and making the expansion too gradual will make the horn unduly long.) In the conical horn, the rate of stretch varies. Near the *throat* the area doubles in only a short distance, whereas it expands more slowly near the mouth.

HORNS

Horn Shapes (contd.)

A horn is effective in producing a *smooth* transition only if it takes not less than $1/18$ th of the wavelength corresponding to the lowest frequency required to double its area. (This relationship has a mathematical basis too advanced to give here, although it has been verified experimentally.) Suppose that the lowest frequency for a horn is to be 400 cycles per second (this is not very low, but is often used for practical equipment, because it results in a useable size): the wavelength for 400 cycles at 1100 feet per second is about 33 inches; so the horn should double its area in *not less than* about 2 inches ($1-5/6$ inches to be exact). In addition, the diameter at the mouth of a horn should not be less than about half a wavelength for the lowest frequency that is to be radiated. For a 400-cycle horn, the diameter at the mouth should not be less than about $16\frac{1}{2}$ inches.

To get the best acoustic energy match into the throat of the horn, a diaphragm about $1\frac{1}{2}$ inches in diameter works into a hole about $\frac{3}{4}$ inch in diameter. The horn thus has to stretch the $\frac{3}{4}$ -inch diameter to about $16\frac{1}{2}$ inches. Doubling the diameter will quadruple the area, and this should never happen in less than 4 inches of horn length.

If it takes 4 inches to build up from $\frac{3}{4}$ to $1\frac{1}{2}$ inches, it will require $4 \times (16\frac{1}{2} - \frac{3}{4}) / (1\frac{1}{2} - \frac{3}{4})$ or 84 inches to reach $16\frac{1}{2}$ inches with a conical horn. This is a horn 7 feet long, to handle frequencies only down to 400 cycles per second. But it is only this long to get the correct rate of stretch near the throat. If we make a horn of a group of cones so that the diameter doubles every 4 inches, it will be:

Distance from throat (inches)	0	4	8	12	16	20
Diameter (inches)	$\frac{3}{4}$	$1\frac{1}{2}$	3	6	12	24

The required diameter is reached between 16 and 20 inches from the throat. Even this shape is not ideal, because the rate of stretch is not quite uniform—it changes suddenly where the conical sections join. The best shape smooths out these joints, so that the stretch is uniform. This shape is called *exponential*.

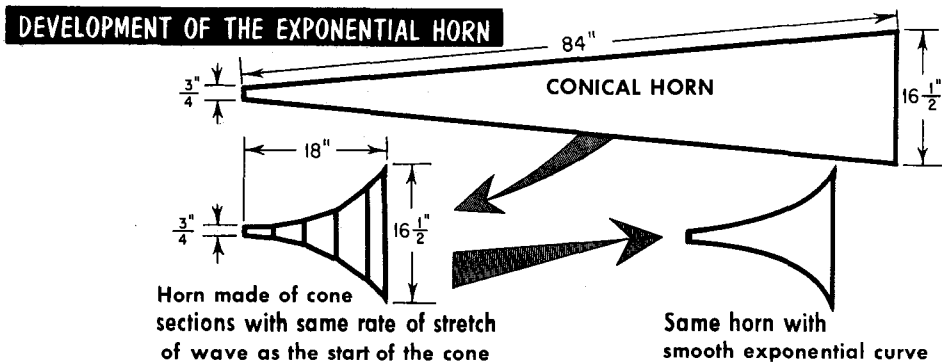

HORNS

Horn Shapes (contd.)

If a horn is required only for frequencies above 800 cycles the rate of flare could be increased. It could double its diameter every 2 inches of length instead of every 4 inches. In addition, the mouth could be half the size.

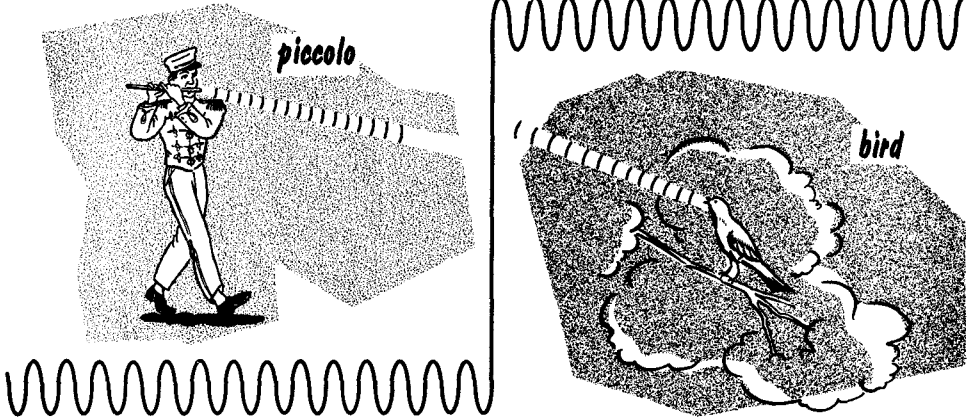

LOW-FREQUENCY SOUNDS NEED A LARGE HORN

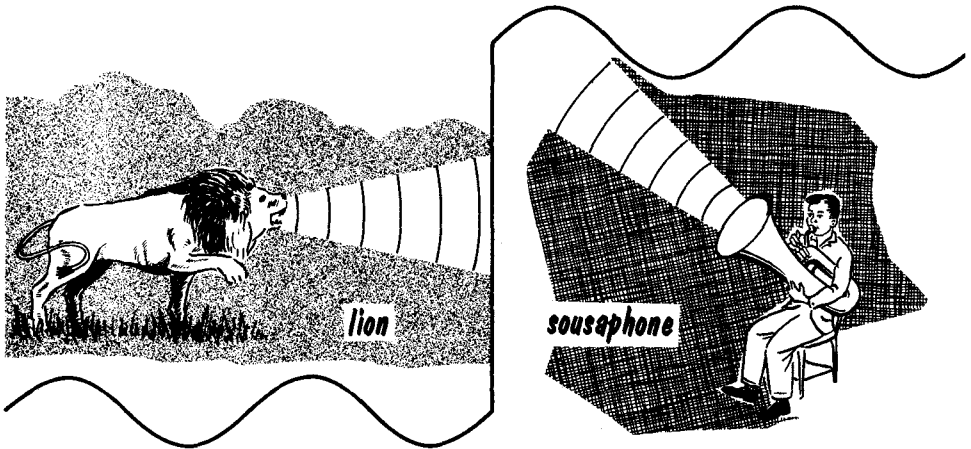

From this we can see a pattern emerging: low frequencies need a big thing to radiate them successfully, but high frequencies can come from quite small objects or sources. Which explains why small birds chirp at higher frequencies, and only larger animals, like lions, can produce a deep-throated roar.

HORNS

The Folded Horn

The horn is a wonderful way to improve acoustic efficiency, but where we really could use this help—at the low frequencies—it has to be very large. For example, to get down to 100 cycles, the mouth needs to be 5 feet across, and the length, starting from a throat 4 inches across, needs to be 64 inches, (over 5 feet). To work from a $\frac{3}{4}$ -inch throat, using a regular horn drive unit, we would need a horn over 9 feet long.

To show that the principle works, horns about 30 feet long have been built, getting down to 40 cycles. But these are hardly practical for everyday use. The 100-cycle horn however is not so very big, although it is somewhat awkward. This can be overcome by “folding” it.

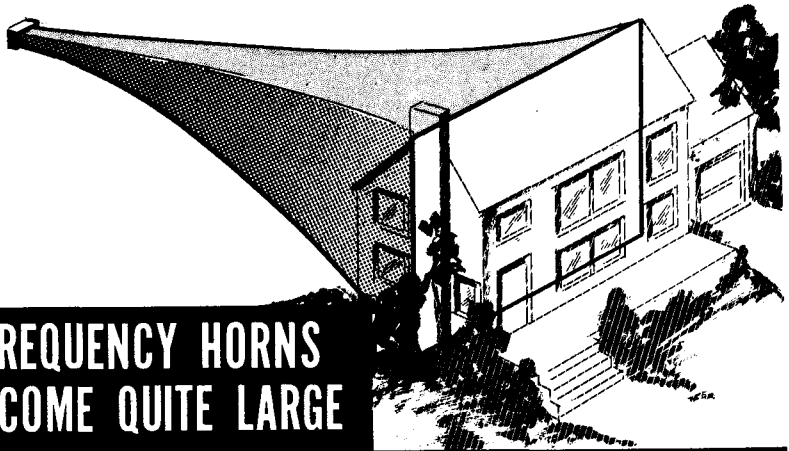

**LOW-FREQUENCY HORNS
CAN BECOME QUITE LARGE**

BUT FOLDING HELPS

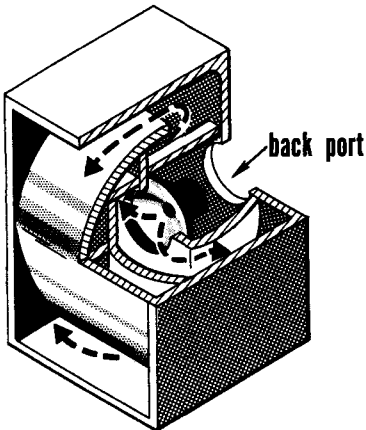

Double-Folded Horn

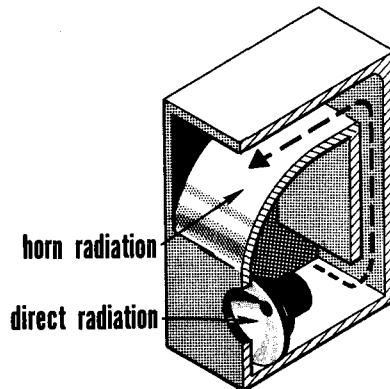

Back-Loaded Folded Horn

HORNS

The Folded Horn (contd.)

For low frequencies, the folding of a horn has no disadvantages—in fact, any horn can be folded without disadvantage to frequencies near the lower end of its frequency range. However frequencies that are well above the cutoff frequency (the lowest it will handle) tend to get “lost” due to folding. Different paths down the horn have somewhat different lengths, and the higher frequencies can get to a condition in which the wave following a longer path cancels one taking a shorter path.

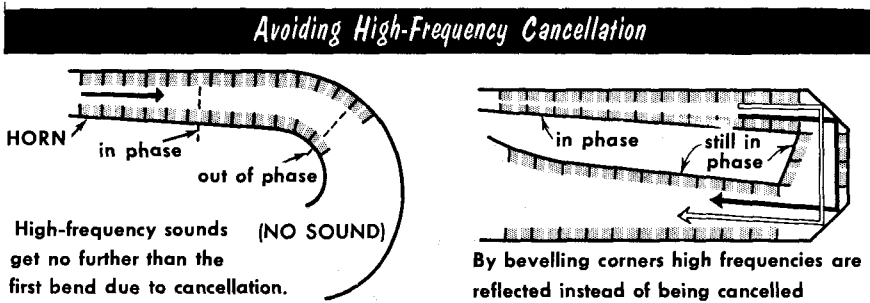

One way in which to compensate for this problem is to design the bends of the horn so as to “invert” the waves at higher frequencies, thereby equalizing the path lengths. Instead of following a smooth contour at the corners, the shape is arranged to reflect the complete wave.

For horns designed for higher frequencies, a very convenient form of construction is the re-entrant type horn, in which the whole structure is concentric.

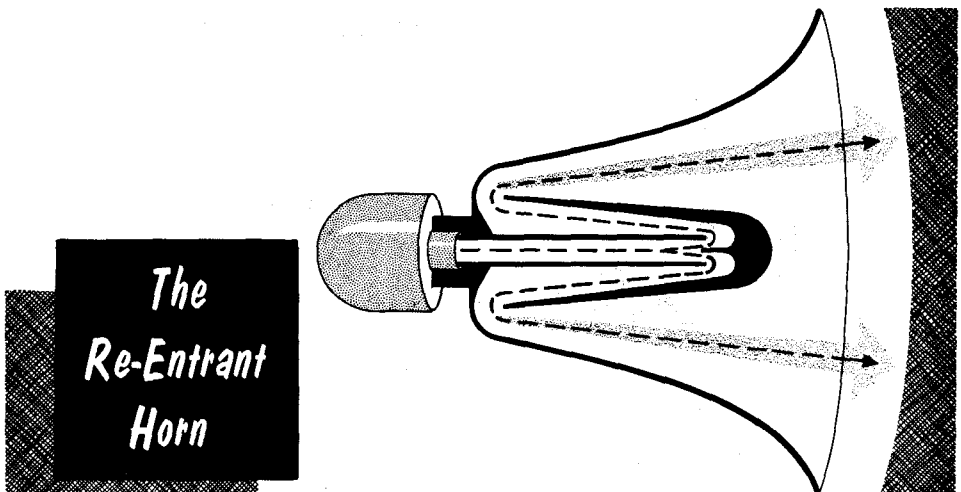

HORNS

Horn Directivity

Like the original megaphone, horns tend to be directional in their radiation of sound. The strongest part of the wave is the section formed by the horn development. Radiation outside this angle is due to a kind of spill-over.

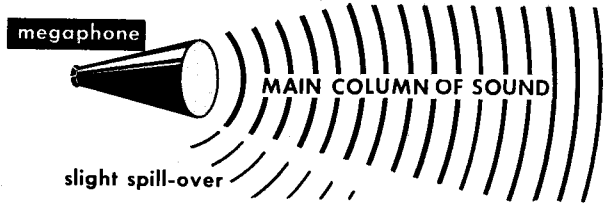
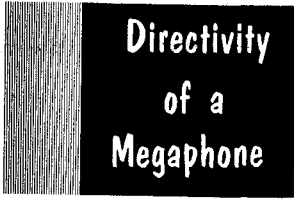

The directivity of a horn is dependent on its precise shaping. For example, a shape called the *tractrix*, which is nearly identical with the exponential shape, except at the mouth, is designed to produce hemispherical waves; in other words, to cover the entire 180° in front of its mouth. This ideal distribution from the tractrix only exists at the lower frequencies it radiates. At higher frequencies, the bell has progressively less effect.

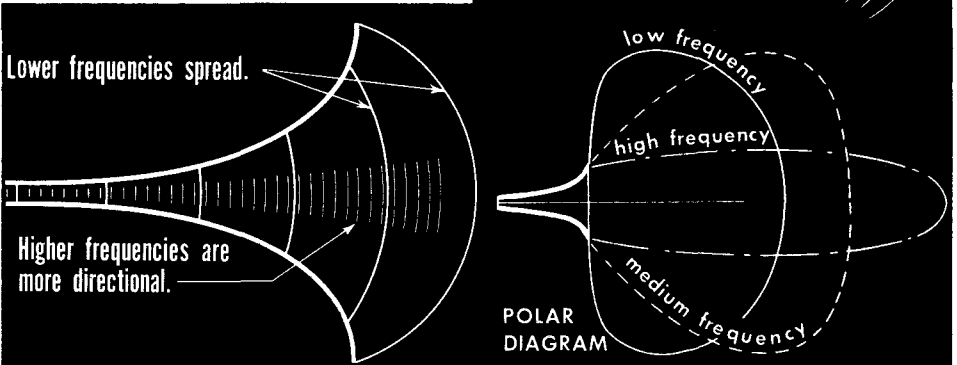
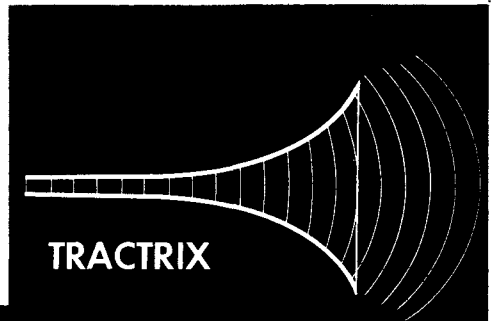
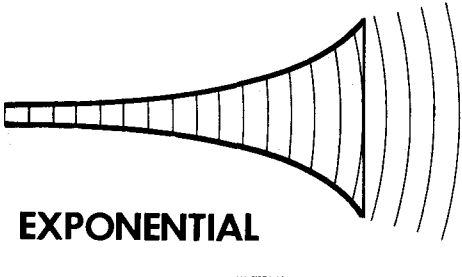

DIFFERENCE IN BELL SHAPE AFFECTS RADIATION

HORNS

The Acoustic Slit

THE DIRECTIVITY OF AN

ACOUSTIC SLIT RADIATOR

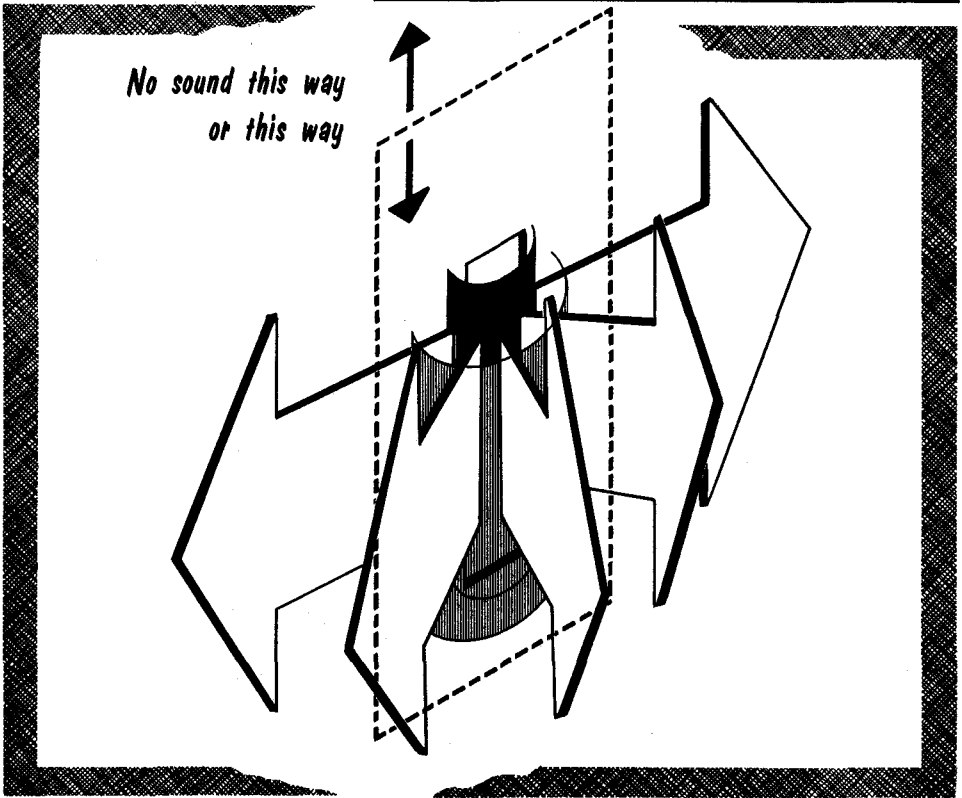

The only way to improve the uneven distribution at different frequencies is to use a different principle altogether. One such is an acoustic-slit radiator. Because the whole length of the slit "puffs" and "sucks" at the same time, it generates a cylindrical wave, with the slit as a center line. The slit will work well provided that its length is greater than half a wavelength, and its width is less than half a wavelength. Thus its length and width fix the range of frequencies for which it is effective.

As an example, a slit 10 inches long and 1 inch wide will be effective between about 600 and 6000 cycles. Below 600 cycles it will be ineffective because of acoustic mismatch (unsatisfactory transition from the slit to free space); above 6000 cycles the radiation begins to concentrate into a beam.

HORNS

The Acoustic Lens

The Effect of an Acoustic Lens

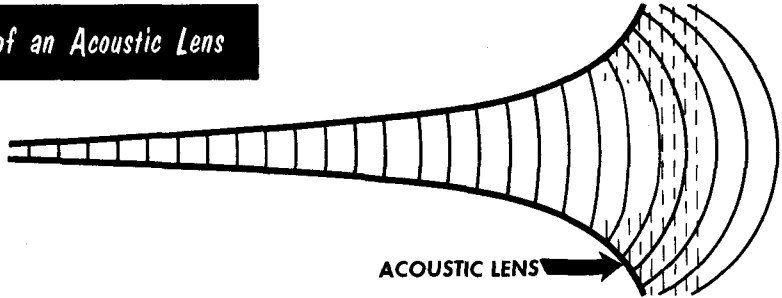

The best solution for wide ranges of frequency is the acoustic lens (a series of perforated or parallel plates). Like its counterpart in waveguide radio, it is effective *above* a certain limit frequency. As the ordinary horn construction, using a tractrix or similar mouth, can be effective *up to* a frequency where the bell ceases to have effect, the lens can be arranged to take over from there and effectively scatter all frequencies above that point.

Another system is based on the fact that high frequencies are subject to reflection by surfaces a wavelength or more in size. This method uses "deflector" plates inside a horn. The bell distributes the lower frequencies, and the deflectors take care of the higher ones.

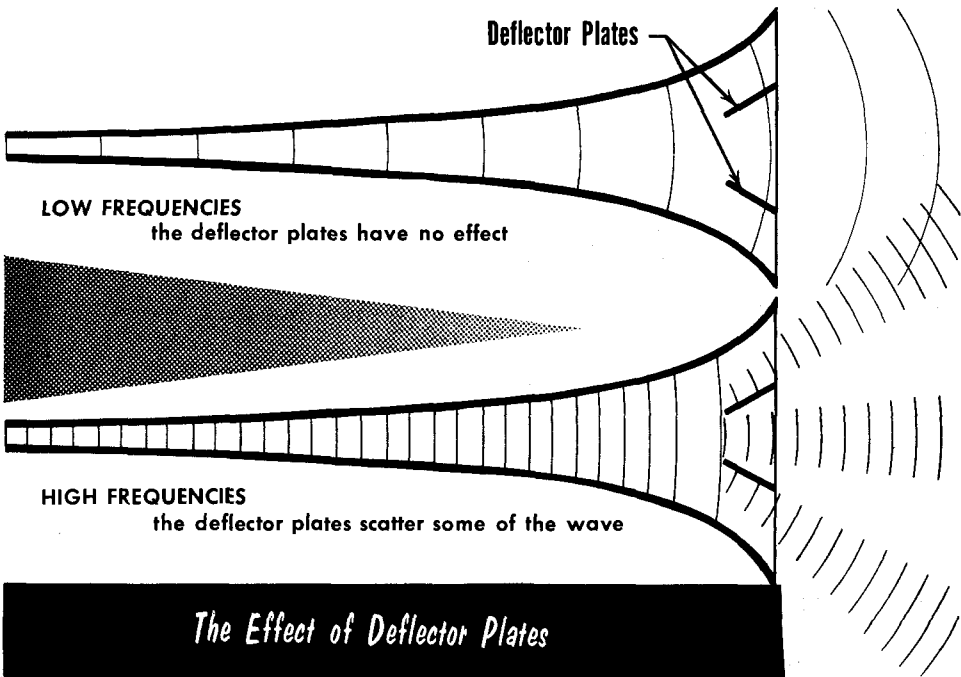

OTHER TYPES OF SPEAKERS

The Electrostatic Speaker

THE ELECTROSTATIC SPEAKER DIAPHRAGM

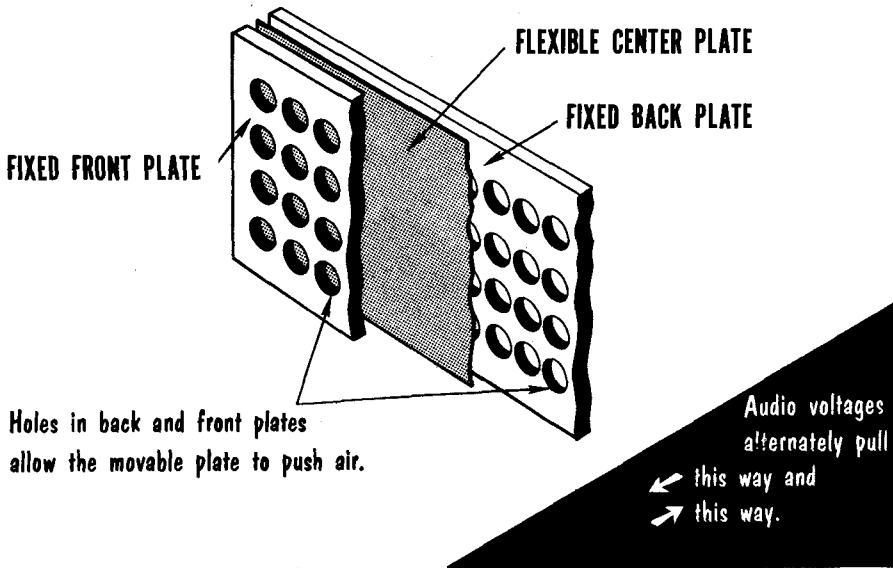

The dynamic or moving-coil transducer has had a very long period of popularity. Much has been done in a great variety of ways to perfect it. The reason for its popularity has been that it has given extremely good results at quite a low cost. For various reasons, however, it is impossible to make it a *perfect* transducer. Therefore some workers in the field have been trying to find a substitute that may do better. One of these is the electrostatic unit.

When a voltage is applied between any two surfaces, it sets up an electric field. This field causes attraction to take place between the surfaces. By varying the voltage, the force of attraction is varied. This is the basis of the electrostatic loudspeaker.

This system has its problems—to get a large force from the applied voltage, the spacing between the surfaces must be very small; making the spaces small means the moving surface has little room in which to move. This means that the electrostatic loudspeaker is either limited to use at high frequencies, where only small movement is required, or else a very large diaphragm size is needed to move enough air for the low frequencies. Some have even suggested building the loudspeaker into a room and having it occupy one entire wall. Between these extremes, some quite useful units have been made, which radiate frequencies above about 800 cycles, using a moving coil woofer for the lower frequencies.

OTHER TYPES OF SPEAKERS

The Electrostatic Speaker (contd.)

Unlike the Moving-Coil Speaker's Diaphragm,

Mechanical drive from voice coil is applied here at center.

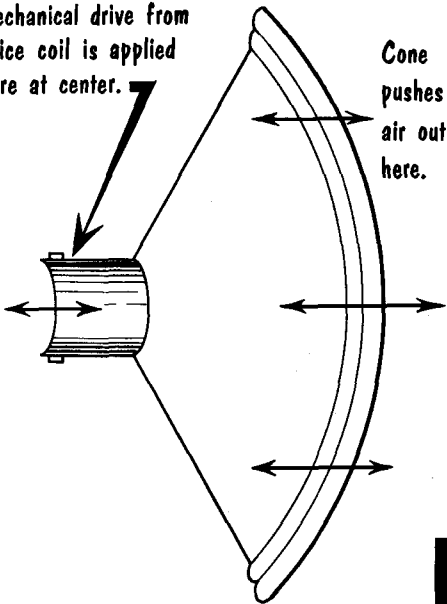

Diaphragm receives electric drive between the holes

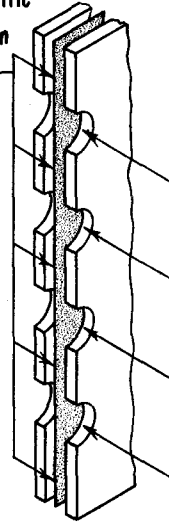

the Electrostatic Speaker's Diaphragm Is Driven Almost Uniformly

The big thing in favor of the electrostatic speaker is the fact that the driving force is distributed over the diaphragm surface. The dynamic loudspeaker is driven from a separate coil. The disadvantage of the coil drive (as any loudspeaker manufacturer knows only too well) is the problem of getting an absolutely rigid mechanical coupling between the drive coil and the diaphragm that is not so heavy that it prevents movement at high frequencies. Choice of material and construction is always a compromise for this reason. The electrostatic units avoid this problem by driving the diaphragm over its entire surface in addition to producing sound from the entire surface. This means that the mechanical properties of the diaphragm (so critical in the moving-coil speaker) become relatively unimportant.

Another problem involved with the use of the electrostatic unit will be better understood in a later section of this course; it concerns matching from the output of the amplifier. The moving-coil speaker is much easier to use from this standpoint.

OTHER TYPES OF SPEAKERS

The Crystal Speaker

THE BASIC CRYSTAL SPEAKER MECHANISM

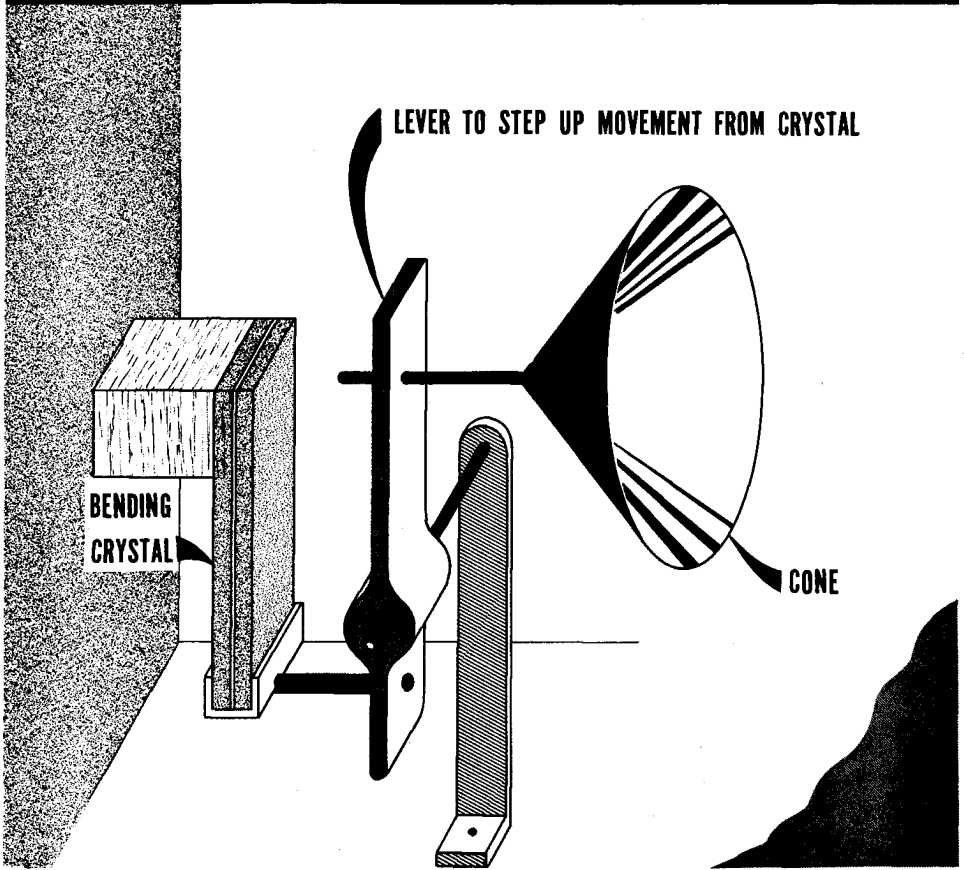

The piezoelectric transducer can also be used for loudspeakers. Again it needs the lever principle to get enough movement to the diaphragm. If the moving-coil speaker type suffers due to the mechanical problems in the drive from a simple coil attached directly to the diaphragm, it is obvious that this more complicated drive is going to have problems. Nonetheless, the crystal speaker enjoyed some popularity as a very cheap unit during a period when the moving-coil speaker was relatively expensive. Improved materials and production techniques for moving-coil speakers have reduced their cost and made the crystal-type loudspeaker virtually obsolete.

OTHER TYPES OF SPEAKERS

The Ionophone

A loudspeaker with no moving parts

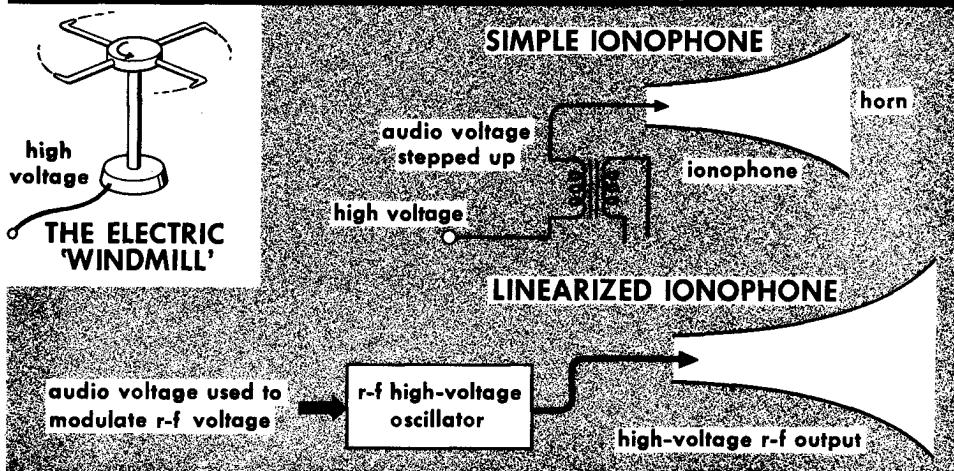

With every kind of loudspeaker, there has always been the problem of mechanical parts which can add effects of their own to the sound radiated. It has long been a dream among idealists in high-fidelity circles to find a loudspeaker which had no moving parts, but converts electrical waveforms directly into sound waves. For this reason the *ionophone* has a strong appeal.

Its operation is based on the electric wind principle. When a high voltage is connected to a point, a discharge takes place from the point, in the form of wind. By having the high voltage vary in accordance with the audio waveform, the wind leaving the point will vary in velocity and produce a sound wave to correspond.

The velocity of the wind is not strictly proportional to the applied voltage. Quite a high voltage is needed before the wind starts, and then its velocity rises quickly. A way of avoiding the distortion this would cause is to use high voltage alternating at a radio-frequency and modulate it with the audio.

Its popularity has been delayed by the problem of getting enough wind to "generate" the lower frequencies. Many points could be used instead of one, but then there are apt to be acoustic problems as severe as the mechanical ones we want to avoid. Another acute problem is the wind itself. It is much more difficult to get a stream of air quiet enough not to obtrude into the quieter program passages than it is with an electron stream in an electronic tube or transistor.

One advantage to the thing, if these difficulties are solved, is that no detector is needed in handling radio signals. The radio signal input itself is simply amplified and fed directly to the ionophone.

QUESTIONS AND PROBLEMS

1. Compare the action of a moving-iron and moving-coil loudspeaker, showing why the latter have come to be almost universally used.
2. Explain the purpose of the cone, coil, spider, and surround of a moving-coil speaker. Why does a moving-coil speaker have to be so much larger than a moving-coil microphone?
3. Why is some sort of baffle needed for a loudspeaker? Is there any alternative to using a baffle?
4. What is an infinite baffle? Explain why it reduces loudspeaker efficiency if made too small.
5. What two facts are utilized in a bass-reflex baffle?
6. Explain how a reflex baffle reverses the phase of the radiation from the back of the speaker diaphragm. Does this happen at all frequencies?
7. How is the size of the port in a bass reflex enclosure determined?
8. Explain why use of a horn improves the efficiency of a loudspeaker. Why is a simple cone not a good shape for a horn?
9. Show by a simple derivation why the exponential form is the best horn shape. What limits the frequency of a horn loudspeaker (a) at the low-frequency end and (b) at the high-frequency end?
10. Assuming two horns that have the same throat diameter (say, $\frac{3}{4}$ inch), what would be the approximate relationship between their lengths if one works from 100 cycles and the other from 200 cycles?
11. Space can be saved by folding a horn, but what problem does this introduce, and how may it be partially solved?
12. What part of a horn is principally responsible for its directional characteristics in radiation? Give examples and show limitations.
13. Describe briefly (a) the acoustic lens and (b) the acoustic slit, as a means for modifying the radiation properties of a loudspeaker, showing what properties control the frequencies at which their effect becomes active.
14. What are the principal attraction and the main limitation of an electrostatic loudspeaker?
15. What was the principal appeal of the crystal loudspeaker? Why has it become obsolete?

IMPEDANCE MATCHING

Matching

This Is Matching

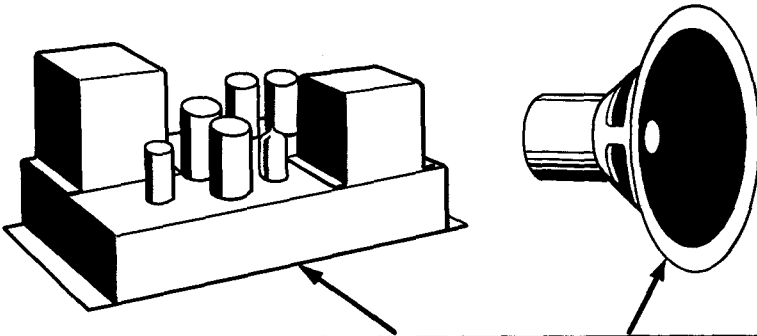
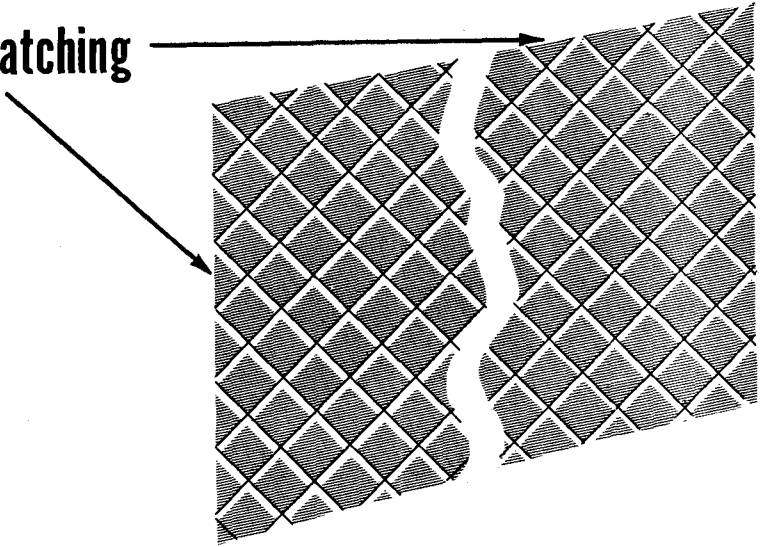

But How Do You Match These?

When the word “matching” is used about paint, fabric, or in a repair job, its meaning is obvious; however, when we speak about matching a loud-speaker to an amplifier, the meaning can at first be mystifying! The word is used to refer to electrical properties. An amplifier performs properly when the right kind of electrical impedance is connected to it. If, by some lucky chance, the speaker voice coil impedance is just what the amplifier needs, it is said to *match* it. This does not usually happen so conveniently, and some circuit finagling, known as *matching*, is required to achieve the best performance.

IMPEDANCE MATCHING

Matching (contd.)

Some variation in the electrical impedance, or resistance, of the loudspeaker can be made by winding the voice coil differently. A single layer of turns may have a resistance of 1 ohm. By halving the diameter of the wire, twice as many turns will go in the same layer length, and we can get two layers in the same thickness. The wire has one quarter the cross section, will be four times as long, giving (4×4) or 16 times the resistance: 16 ohms. Using wire of one-third the diameter originally used, we can use nine times as many turns at 9 times the resistance per turn, which yields $(9 \times 9 \times 1)$ or 81 ohms.

VOICE COILS CAN BE WOUND WITH DIFFERENT NUMBERS OF TURNS

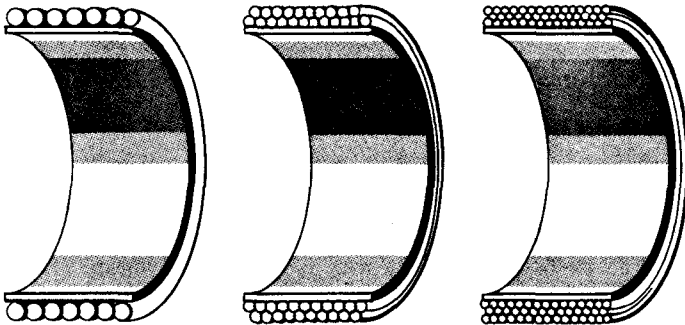

1 layer

2 layers

3 layers

In this way the voice-coil resistance can be changed to some extent by choice of winding. Common commercial values for voice-coil resistance are 1 ohm, 2 ohms, 4 ohms, 8 ohms, and 16 ohms. Some, for special purposes, have a resistance of 45 ohms, and coils have been wound to resistances as high as 500 or 600 ohms. (These coils have a great many turns of extremely fine wire—too fine for a robust coil, and they tend to give trouble in service.)

Even 500 or 600 ohms is rather too low a resistance to match most amplifiers, hence a matching arrangement is still required. Once this is the case, it is as easy to match from 1 ohm as it is from 600 ohms (or any value between, of course), and there is no longer any point in making such fragile coils.

IMPEDANCE MATCHING

The Matching Transformer

A matching transformer for a loudspeaker is just like one used to step up the output from a microphone, except that it is bigger, and designed to handle much more power. Suppose that a transformer is to match a 16-ohm loudspeaker to an amplifier requiring, not 16 ohms, but 6400 ohms, to which it is to deliver its power.

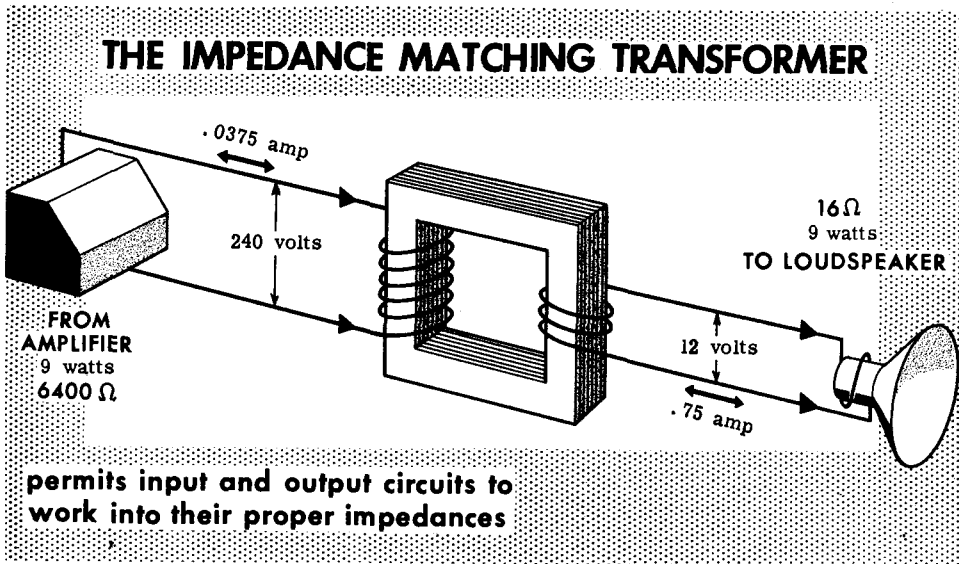

Suppose 9 watts are to be transferred. The formula for power is $W = EI$, where W is power in watts, E is voltage in volts, and I is current in amperes. (Remember that the relation between voltage and current in a resistance is $E = IR$, where R is the resistance in ohms.)

Combining the two formulas, $W = EI = E \times E/R = E^2/R$. Then by multiplying both sides by R , $WR = E^2$. In the example, $WR = 9 \times 6400 = 57,600 = E^2$. Hence, $E = \sqrt{57,600} = 240$ volts. Also $I = E/R = 240/6400 = .0375$ ampere.

At the voice-coil resistance, $WR = 9 \times 16 = 144 = E^2$. Hence, $E = \sqrt{144} = 12$ volts. $I = E/R = 12/16 = 0.75$ ampere.

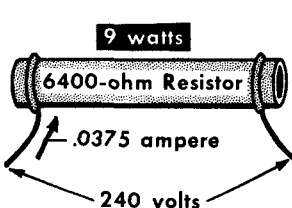

$$W = E \times I$$

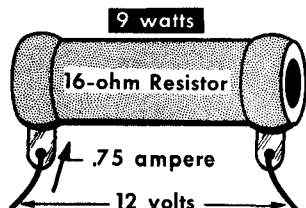

IMPEDANCE MATCHING

The Matching Transformer (contd.)

But what would happen if a matching transformer were not used? The amplifier is only designed to deliver .0375 ampere into a 6400-ohm resistance or *load* as it is called. If it is connected to 16 ohms, it will probably not deliver much more than .05 ampere—maybe .05 ampere—and the waveform will be very distorted. When .05 ampere is delivered to 16 ohms, the voltage is only $E = IR = 16 \times .05 = 0.8$ volts, and the power delivered is only $W = EI = 0.8 \times .05 = .04$ watt, in place of the expected 9 watts!

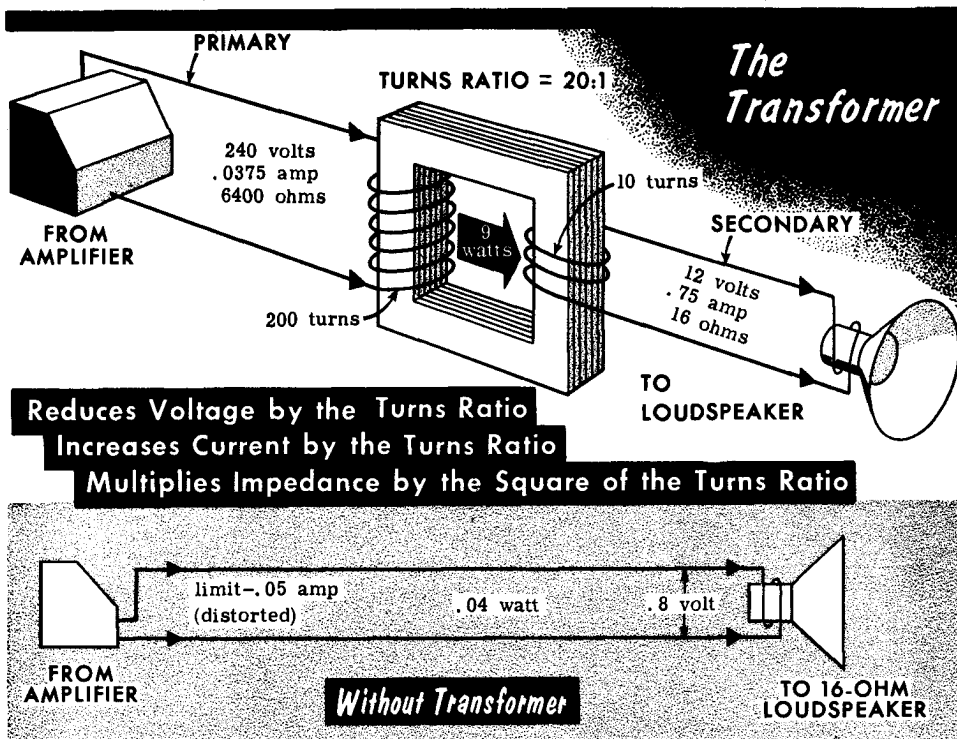

Notice what the transformer does: it reduces the voltage by the ratio of turns in the windings (called the *turns ratio*) and it also increases the current by the same ratio. It thus effectively multiplies the resistance (or impedance) connected to the secondary by the *square* of the turns ratio. In this case, the ratio was 20:1. The impedance connected to the secondary is multiplied by $20 \times 20 = 400$ ($16 \times 400 = 6400$ ohms). The input voltage is 240 volts and the output is 12 volts; the input current is .0375 ampere and the output 0.75 ampere. The input and output power are the same (except for any losses due to the inefficiency of the transformer, which we have conveniently ignored; in practice, an output transformer would be more than 90% efficient, so this is no very great error).

IMPEDANCE MATCHING

The Matching Transformer (contd.)

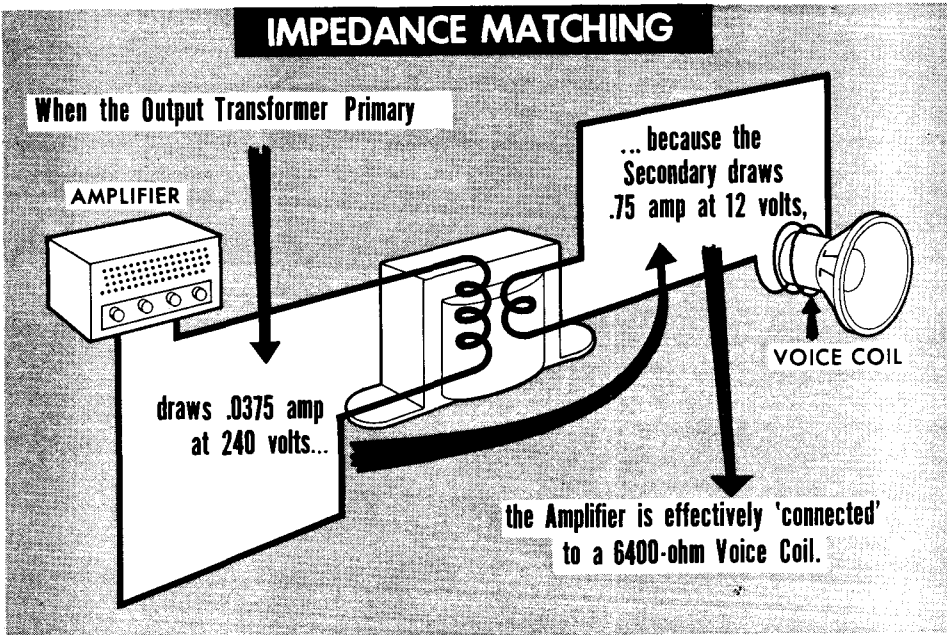

When the amplifier supplies 240 volts to the “high” winding of the transformer, the core will be magnetized, and, due to its high inductance, very little current will be drawn from the amplifier, unless the voice coil is connected to the low winding.

The high winding must have 20 times as many turns as the low winding. This way, 240 volts induction in the primary will cause 12 volts in the secondary.

When the voice coil is connected across a 12-volt source, it will draw 0.75 ampere. If no current flowed in the primary of the transformer, this secondary current would destroy the induction by saturating the core, and the 12 volts (as well as the 240 volts) would disappear. To sustain the 12 volts, the amplifier must supply current to the primary to neutralize the effect of the 0.75 ampere in the secondary. As the primary winding has 20 times as many turns, it will only require one-twentieth the current, or .0375 ampere, to have the same effect and neutralize the effect of the secondary current.

Thus the transformer causes the primary winding to take .0375 ampere from the amplifier at 240 volts, when the secondary is connected to a voice coil of 16 ohms that takes 0.75 ampere at 12 volts. To the amplifier, it is the same as connecting a voice coil with a resistance of 6400 ohms, which it “wants.” This is matching.

IMPEDANCE MATCHING

The Matching Transformer (contd.)

What would happen if the voice-coil resistance were 20 ohms instead of 16 ohms? If the transformer secondary voltage were still 12 volts, the voice coil would only take 0.6 ampere in place of 0.75 ampere. The turns ratio would still produce 240 volts across the primary winding, but the primary current required to balance the new secondary current of 0.6 ampere will be $0.6/20$, or 0.03 ampere, in place of $0.75/20$, or 0.0375 ampere. This is the same as if a load of $R = E/I = 240/0.03 = 8000$ ohms were connected to the amplifier directly. 8000 ohms is just 400 times the 20 ohms connected to the secondary winding of the transformer. The 20:1 turns ratio of the transformer thus always multiplies the resistance, or impedance, connected to its secondary winding by a factor of 400, or 20 squared (20×20).

**Impedance matching permits
maximum power output**

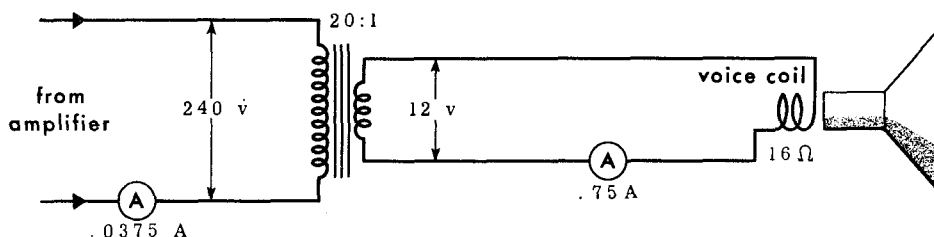

**Amplifier is MATCHED to 16-ohm speaker
Amplifier 'sees' correct 6400 ohms
Output power is 9 WATTS**

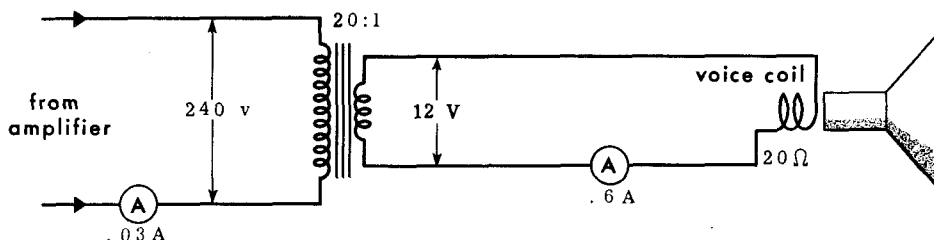

**Amplifier is NOT MATCHED to required
16-ohm, but 20-ohm speaker. Amplifier now
'sees' 8000 ohms - Output power is 7.2 Watts**

DIVIDING NETWORKS AND CROSSOVERS

Dividing Networks

When a number of loudspeakers—two or three—are used to cover the frequency range, one handles the low frequencies, another the high frequencies, and sometimes a third one handles the middle frequencies. When the two-speaker idea was introduced, the low-frequency speaker was called a *woofer* and the high-frequency speaker a *tweeter* (for obvious reasons). The addition of a middle-to-upper range unit led to the name *squawker* (a rather doubtful description). Some prefer to call the mid-range speaker (which is still “high” in the musical sense) the *tweeter*, and the unit that handles the extreme highs is called a *super-tweeter*. In any event, whatever the units are called, each should only get the frequencies that it is supposed to handle.

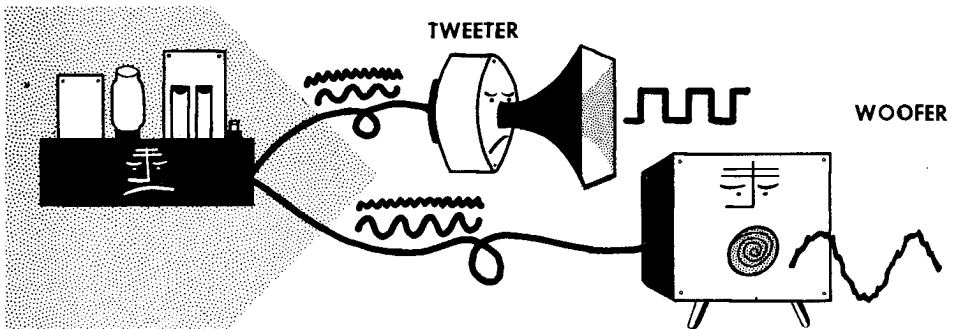

Each Speaker Should Only Get The Frequencies That It Is Designed To Handle

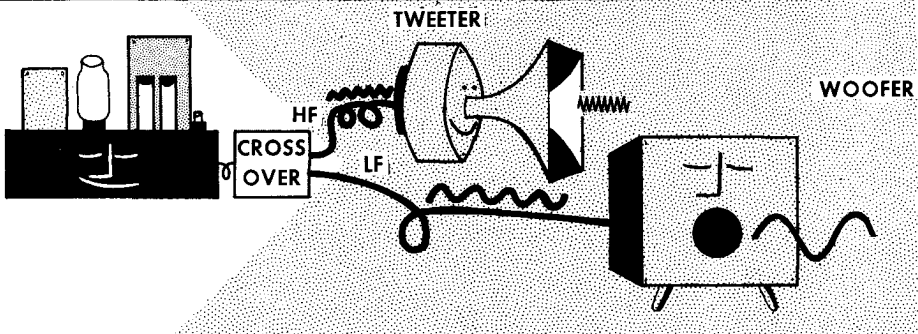

If the low frequencies are fed to a unit not designed to accept them, it will rattle and distort badly. Feeding frequencies higher than a unit is intended to handle will not cause any particular distortion, but will result in loss of power at these frequencies, because the voice coil will accept the power, although incapable of delivering corresponding sound waves. For this reason, *dividing networks* are needed so each unit gets “what is coming to it.”

DIVIDING NETWORKS AND CROSSOVERS

The Series R-C Network

Dividing networks are circuits capable of discriminating (to some extent) between frequencies that are higher or lower than a certain value. Although this may sound quite an "intelligent" action on the part of a mere circuit, there is nothing basically difficult about it.

ACTION OF THE SERIES R-C DIVIDER

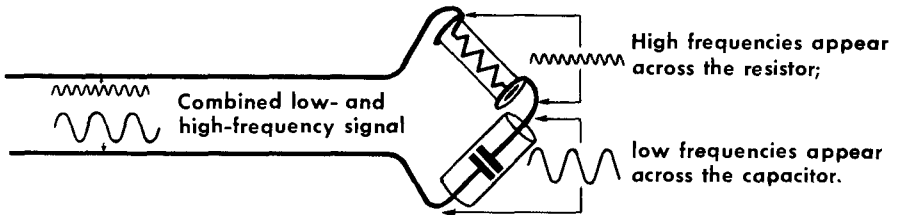
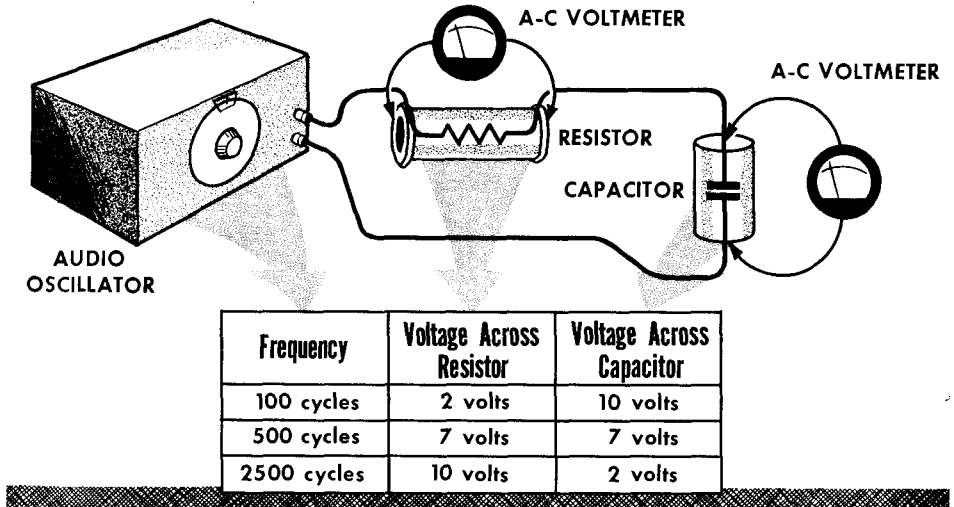

At a low frequency, the charge on the series capacitor follows the fluctuations, and the voltage across it very closely follows the input voltage, only a small current flows, and very little fluctuation appears across the resistor. At a high frequency, the charge on the capacitor does not have time to follow each fluctuation, and the whole of the applied voltage appears across the resistor.

At a medium frequency, some of the voltage appears across the capacitor and some across the resistor due to the current required for charging the capacitor. When a combined program is applied across the resistor-capacitor combination, the low frequencies get concentrated across the capacitor, and the high ones across the resistor.

DIVIDING NETWORKS AND CROSSOVERS

The Series R-L Network

ACTION OF THE SERIES R-L DIVIDER

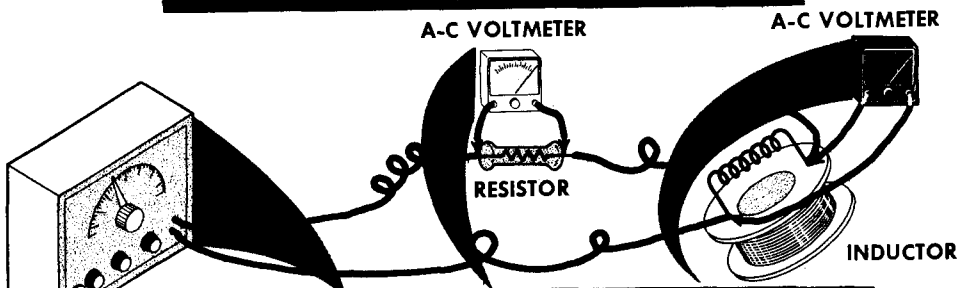

Frequency	Voltage across Resistor	Voltage across Inductor
100 cycles	10 volts	2 volts
500 cycles	7 volts	7 volts
2500 cycles	2 volts	10 volts

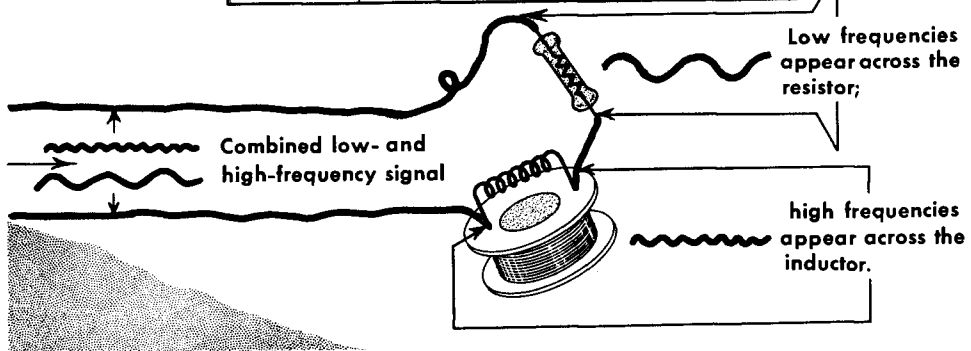

A combination of resistance and inductance will also separate frequencies. Whereas a capacitor takes a flow of charge ($\text{current} \times \text{time}$) to change the *voltage* across it, an inductor requires that energy be used to change the magnitude of the *current* passing through it. At low frequencies, the current has plenty of time to change, hence the voltage across the inductor does not fluctuate appreciably. (Most of the fluctuation appears across the resistor.) At high frequencies, the rate of fluctuation does not allow time for current in the inductor to change, and the resistor voltage and current are almost constant. (Most of the input voltage appears across the inductor.)

At a middle frequency, some of the voltage appears across both components, because the current changes, requiring a voltage across the inductor to make it do so. When a combined signal is applied across the resistor-inductor combination, the low frequencies get concentrated across the resistor, and the high ones across the inductor. Either of these arrangements would be quite satisfactory to separate *voltages* of different frequencies.

DIVIDING NETWORKS AND CROSSOVERS

Parallel, R-C, and R-L Networks

ACTION OF THE PARALLEL R-C DIVIDER

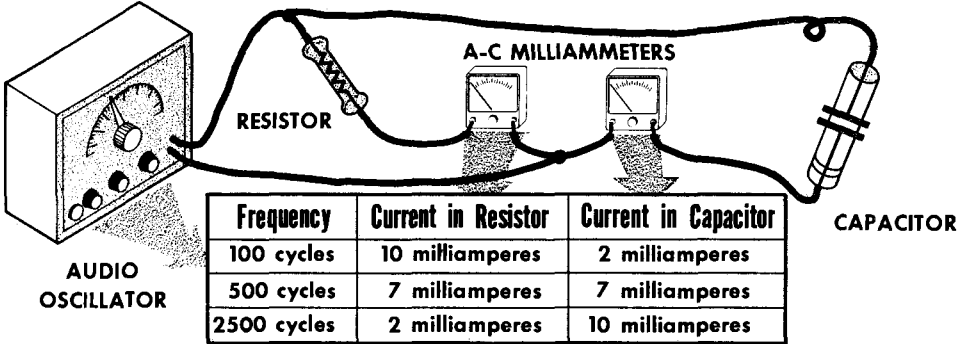

Currents of different frequencies can be separated by connecting the same components in parallel. With a resistor and capacitor in parallel, the resistor draws the current at low frequencies, the capacitor at high frequencies, and in the middle range, the current is shared. With a resistor and inductor in parallel, the resistor draws the current at high frequencies, the inductor at low frequencies, and in the middle range, the current is shared.

ACTION OF THE PARALLEL R-L DIVIDER

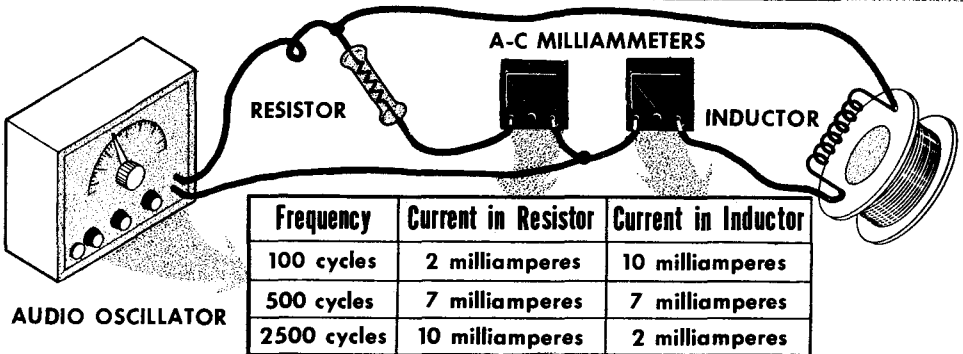

Thus series arrangements separate voltages of different frequencies, and parallel arrangements separate currents of different frequencies. *Power*, however, is absorbed only by resistors, hence all the power supplied to these circuits is dissipated in the resistor, regardless of its frequency. Because loudspeaker units require power rather than merely voltage or current, a simple voltage or current divider of the type that we have discussed thus far will not suffice for sorting out the input to the various loudspeakers in a two- or three-way system.

DIVIDING NETWORKS AND CROSSOVERS

The Parallel-Fed Crossover

To obtain power division, both inductance and capacitance must be used, for even the simplest network. Here the dividing elements do not absorb any power and all the power goes to the loudspeakers. If a capacitor is connected in series with a speaker, it will block the lower frequencies and allow only the high frequencies to get through to the speaker. The loudspeaker with an inductor in series with it will receive only the lower frequencies, because the inductor will block the higher ones.

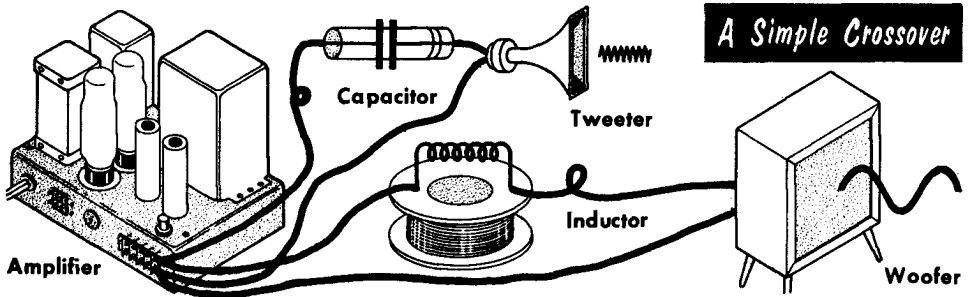

If the right values of inductance and capacitance are used, both loudspeakers will get half the power at a middle frequency, called the *crossover point*. At frequencies below this, more of the power goes to the speaker with the series inductance, whereas above the crossover point, progressively more of the power goes to the speaker with the series capacitor. The *current* between the two loudspeakers is divided in this way. Because each branch of the circuit delivers its current to a load resistance (one loudspeaker), the current is accompanied by a proportionate voltage, and a *power* division results. We can also use these components to effect a power division by dividing the voltage.

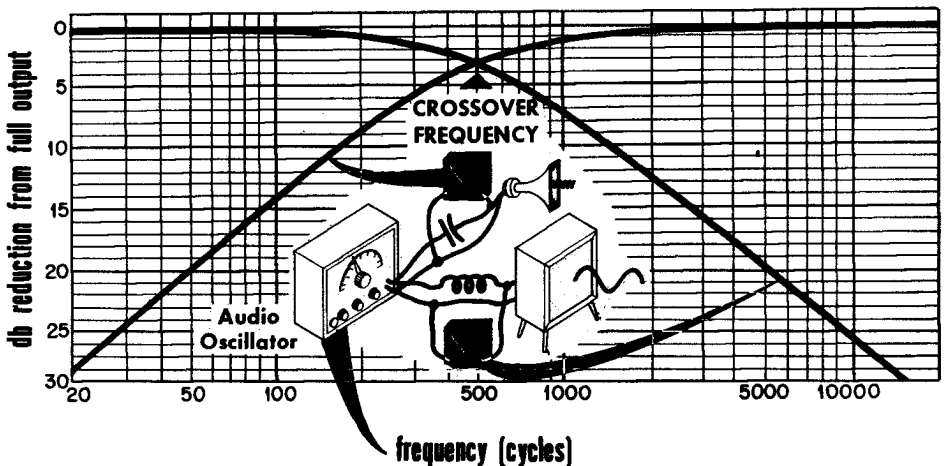

DIVIDING NETWORKS AND CROSSOVERS

The Series-Fed Crossover

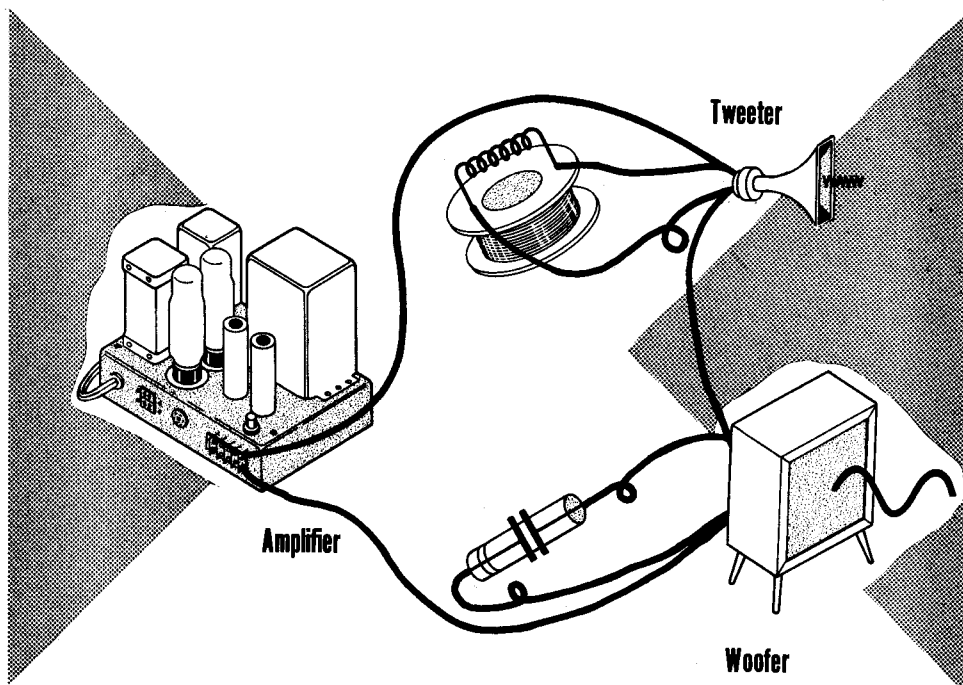

Another Arrangement of the Simple Crossover

For a voltage divider, both loudspeakers are in series, but one has a capacitor in parallel with it, and the other has a parallel-connected inductor. At low frequencies, the inductor bypasses the loudspeaker across which it is connected, so that the other one gets all the low frequencies. At high frequencies, the capacitor bypasses its loudspeaker, and the other speaker gets them. As before, at a middle frequency, the energy is equally divided between both units. The response would be exactly as plotted for the other arrangement. The only differences are the series or parallel connection of the speakers with respect to the amplifier output and the connection of the reactive elements. (In the series arrangement, the capacitor is connected to the woofer and the inductor to the tweeter; in the parallel arrangement, this association is reversed.)

Although the circuits divide power, each of them resembles a simple divider, one for current, the other for voltage. The power delivered to each of the speakers is proportional to this voltage or current division. It is possible to get better frequency separation by using more components in the networks.

DIVIDING NETWORKS AND CROSSOVERS

Two-Element Crossovers

This arrangement works by progressive current division that accentuates the separation. The first division is by series components, connected to the output in parallel. Then each unit has a further component in parallel with it to bypass the unwanted frequencies.

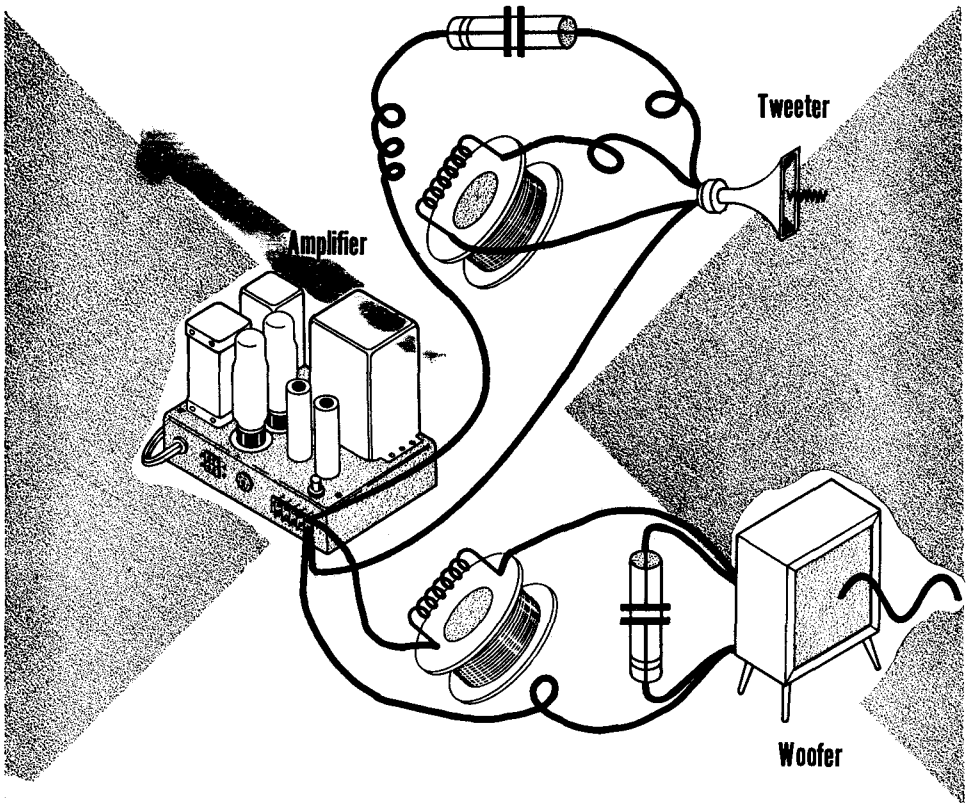

More Complicated Crossover Using Two Capacitors And Two Inductors

The low-frequency loudspeaker is bypassed at higher frequencies by the capacitor connected across it, then the inductor in series with it further blocks higher frequency voltage. However, the action is a little more complicated than this. The inductance and capacitance interact, rather like a tuned circuit in a radio, with the result that the energy is delivered to the low-frequency unit more efficiently at frequencies near to cutoff (the cross-over point). This can be shown by plotting the frequency responses and comparing them with the simple circuits.

DIVIDING NETWORKS AND CROSSOVERS

Two-Element Crossovers (contd.)

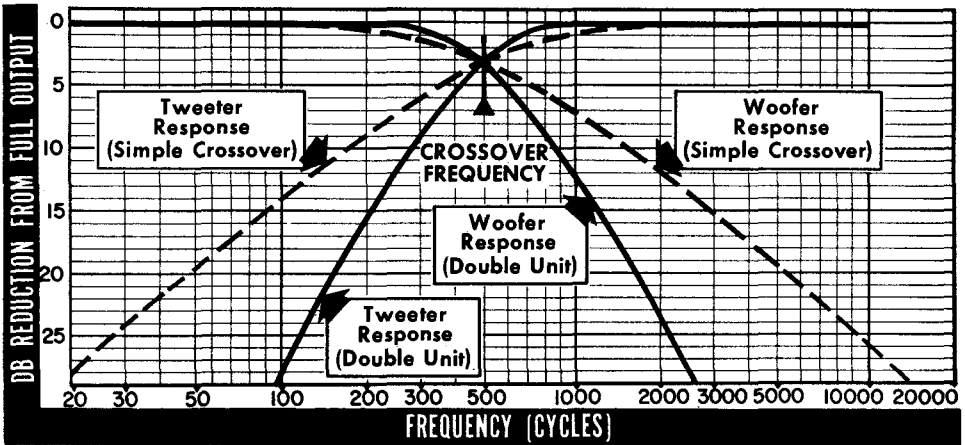

Notice that below the crossover point the low-frequency unit is fed more efficiently with the improved network, and that the response falls off more rapidly above crossover, due to the double action. The same thing happens with the feed to the high-frequency unit: the inductor in parallel with it bypasses the low-frequency currents, and the capacitor in series blocks the low-frequency voltage. The interaction again works like a tuned circuit to improve the efficiency just above crossover point, and to make the response fall off more rapidly below it. The first pair of components divide current, as in the simple current-dividing network, and the component connected in parallel with each unit accentuates the action by redividing the current.

A similar development can be made, using progressive voltage division. Here the voltage-blocking components are in series with each unit, then the current bypass components are in series across the amplifier output to cause voltage redivision. The values of the components are different from those in the other circuit, but the results are the same.

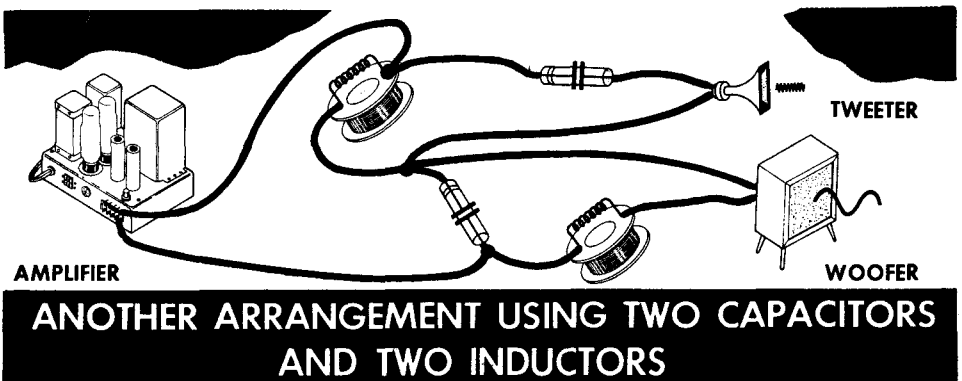

DIVIDING NETWORKS AND CROSSOVERS

Three-Element Crossovers

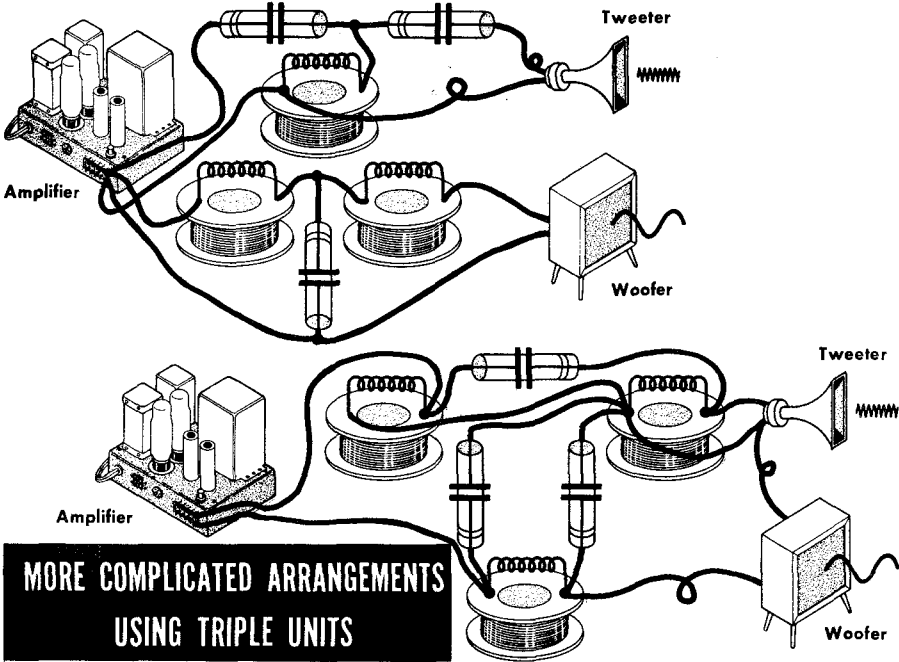

**MORE COMPLICATED ARRANGEMENTS
USING TRIPLE UNITS**

The process of adding components may be continued until there are as many elements or components as desired, although three, as shown here, is usually the limit. Using a greater number of components leads to complications in design, if the response and frequency division are to be correct. The more components used, the more effectively the frequencies are separated; frequencies near crossover point are transmitted more efficiently to the correct unit, and those beyond the crossover point are rejected better.

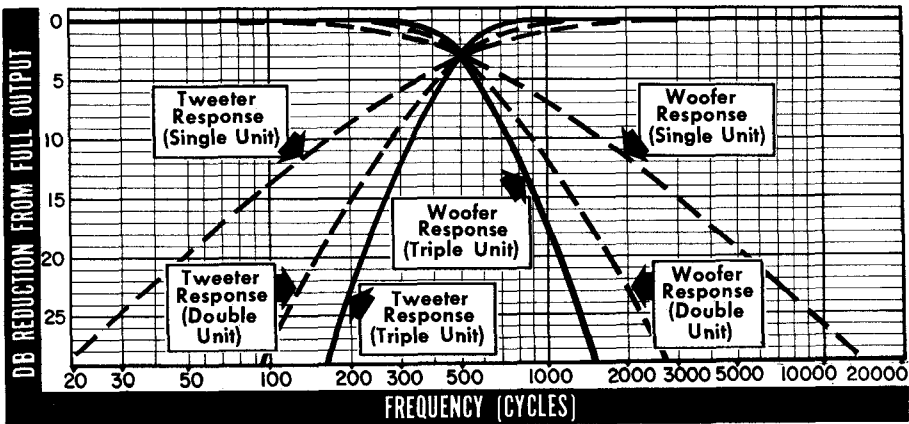

DIVIDING NETWORKS AND CROSSOVERS

Phasing

An important aspect of connecting these networks is called *phasing*. At the one frequency—crossover point—both loudspeaker units are delivering about an equal amount of the total sound energy. It is important that both diaphragms should “push” and “pull” together in *phase*. If one speaker pushes when the other pulls, and vice versa, they are said to be *out of phase*.

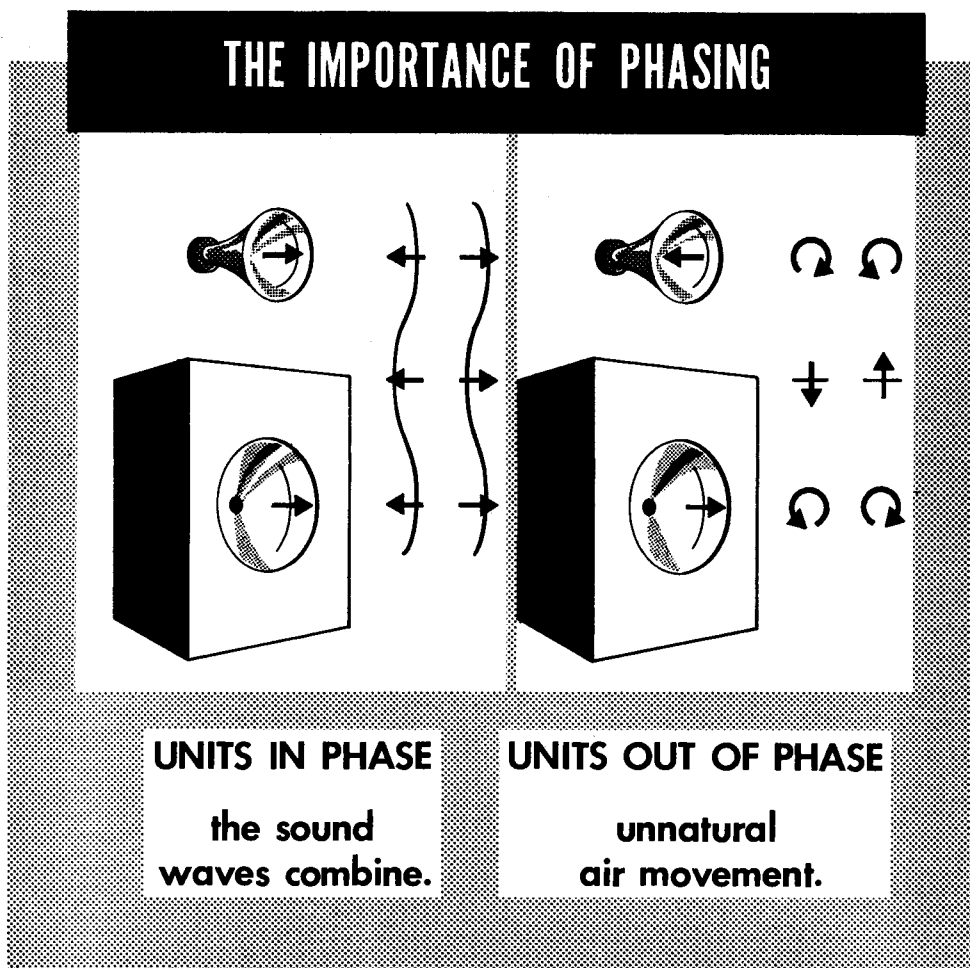

When the units work correctly (in phase), the combined sound wave builds up into the same kind as would be produced by one big loudspeaker unit. When they are out of phase, however, the motion of the air particles is crossways. This makes quite an unnatural kind of sound, and the realism of the reproduction is destroyed. For this reason care should be taken to connect the units so that they are in phase.

RESONANCE

Resonance

The property of resonance plays an important part in audio. For music, it is a property much sought after, but for musical *reproduction*, it is something to be avoided. Every musical instrument has its own variety of resonator. In stringed instruments the strings vibrate at a resonant frequency that fixes the note played, and the resonances in the body of the instrument control the overtone structure. Pipes and horns use a resonant column of air, in which the weight and elasticity of the air particles themselves (and the dimensions of the pipe or tube) control the frequency of vibration. Reed organs use vibrating reeds where the natural frequency of the tongue fixes the tone with resonators that give the desired timbre.

Double Resonance in the Marimba

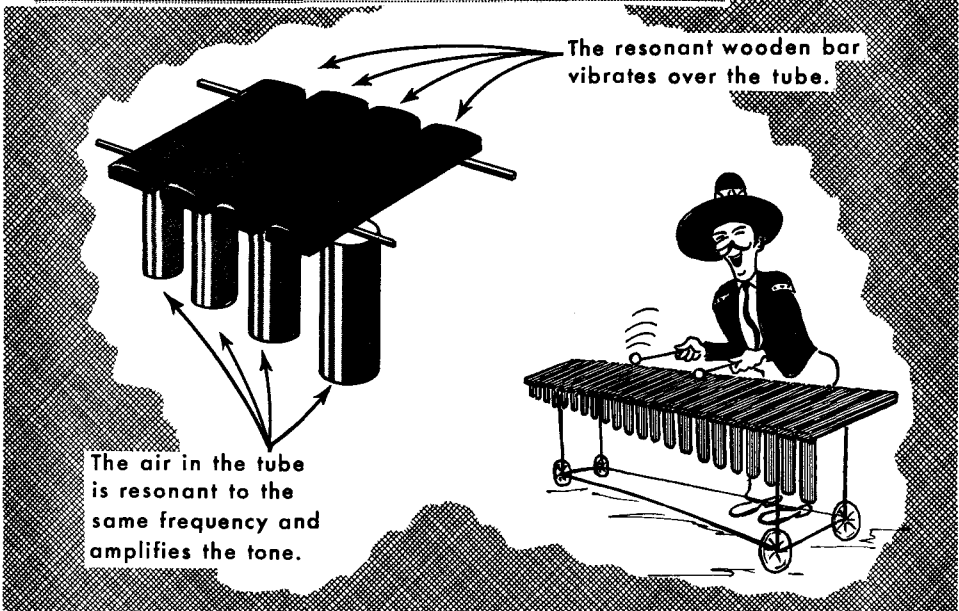

With all these musical instruments, it is a family of resonance patterns that control the production of tones peculiar to that instrument. In the xylophone or marimba, a vibrating piece of wood initiates the tone, which is reinforced and given its fullness of tone by a resonant tube, in which an air column is set in vibration by the feeble vibrations from the wood bar.

In audio, however, resonance is taboo. We want to hear the original instruments' tones and timbres, not some extra effects contributed by the audio system. Unfortunately, it is not possible completely to eliminate resonance from anything with moving parts, such as a microphone, loudspeaker, or phonograph pickup.

RESONANCE

Resonance (contd.)

A telephone diaphragm is a simple steel disk of metal that vibrates according to the currents in the earpiece. It also has its own simple resonance (much like a miniature drum). This tone tends to predominate, giving the quality of speech peculiar to telephone reception. Choice of a suitable resonant frequency (in the construction of the instrument), makes for maximum intelligibility on speech, but music does not sound very good over a telephone.

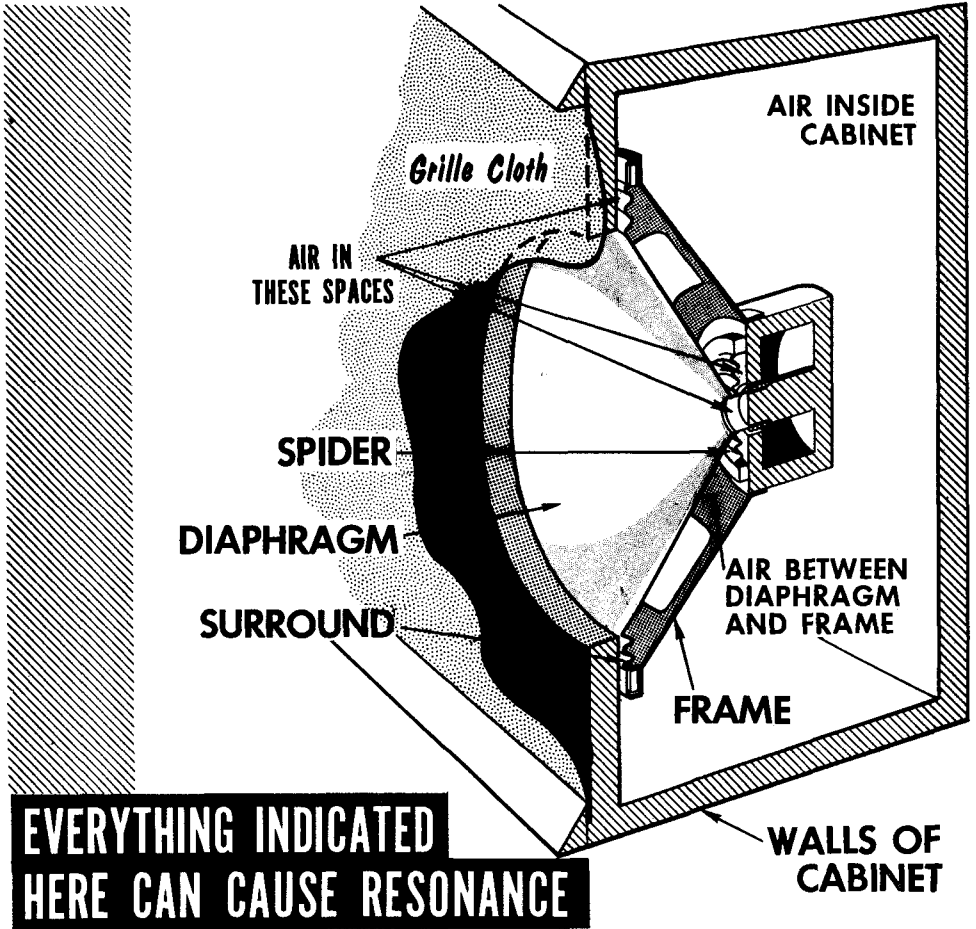

In loudspeaker design, every effort is made to minimize resonance effects, but there are still plenty left. The best that can be done in a good design is to spread the resonances so they all have as little effect as possible. Some manufacturers, from time to time, make the claim of having produced the perfect loudspeaker, with no "tone" of its own. So far, none of these claims has been true, and future claimants should be checked very carefully.

RESONANCE

Resonance (contd.)

The loudspeaker is not the only part of an audio system that is subject to resonance problems. They afflict microphones, phono cutters, pickups, and even some electrical circuits. As a result, it is difficult to be certain that the very simple statements that we have made are readily true.

We said that a microphone converts acoustic vibrations into electrical waves. It does. But how *faithfully* does it do so? Are the electrical waves an accurate copy of the acoustic vibrations? This is very difficult to be sure of, because resonances in almost any microphone will augment some frequencies and diminish others. We know this happens, but by how much?

Determining this is complicated by the fact that rooms in which we try to measure things also have a resonance of their own—standing waves have the same effect as resonances in microphones or loudspeakers; they emphasize some frequencies, and by contrast they diminish others. Thus even if we know about the microphone, how much of the acoustic vibration picked up is due to the original sound wave and how much is augmentation due to standing waves?

Resonance Problems may be caused by:



microphones

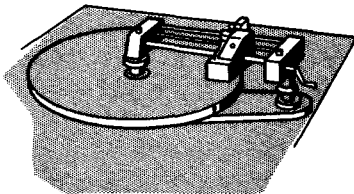

phono cutters

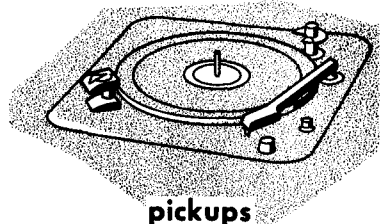

pickups

In view of the extreme difficulty in getting rid of undesirable resonances, it is difficult to make measurements against an *absolute* standard. It is relatively easy to compare two pieces of equipment, either with instruments or by listening. When you know how much they differ, the question remains as to which one is nearest right. Listening can offer a guess, but different people's guesses do not always agree.

The thing we need to establish is a *standard sound field* as a basis for comparison. This means an area in which the intensity of sound vibration itself is accurately known. Anything that involves the use of mechanical movement to measure movement of air particles brings in the problem of resonance, which will make the method give different answers at different frequencies. For this reason, *standards* of wave measurement use devices that do not depend on transmitting the movement to mechanical parts to measure it.

AUDIO RESPONSE CURVES

The Rayleigh Disk

The principal difficulty in measuring the intensity arises due to the very small amount of energy in a sound wave. One method, discovered by Lord Rayleigh, uses the *Rayleigh disk*. It is still used today.

The Action of the Rayleigh Disk

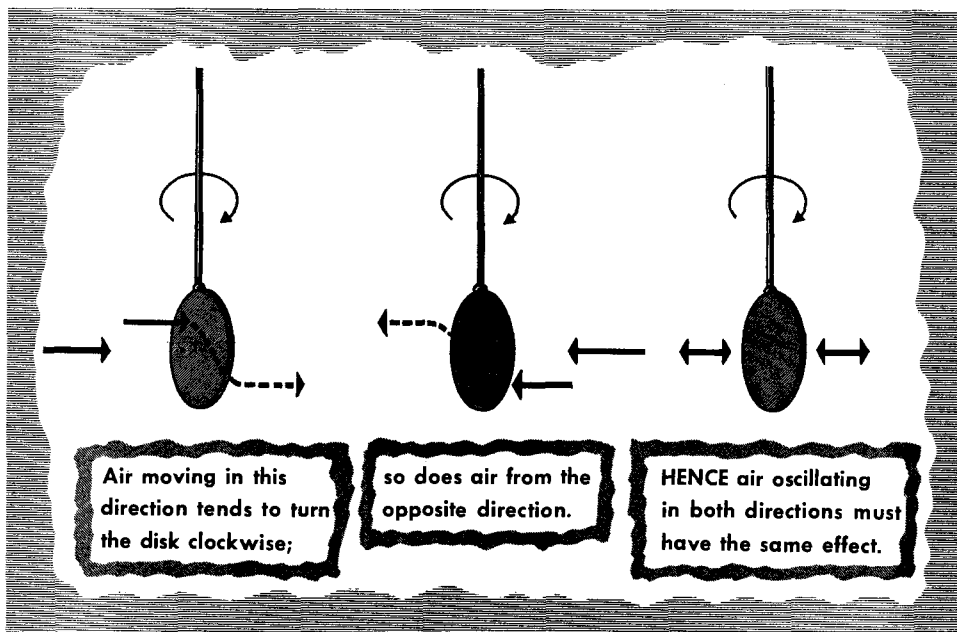

When a small disk is suspended in air, any air movement striking it tends to set the disk "head on" to stop the air. This happens whichever side the movement comes from. In a sound wave, the movement comes alternately from opposite sides, as air particles move back and forth. Both movements tend to turn the disk the same way, hence the torsion on the disk will depend on the *amount* of air particle movement, not its direction or frequency.

To use this delicate instrument, the disk is carefully hung at a definite angle to the approach of the sound wave to be measured, and shielded from any other air currents. Then the thread by which it is suspended is twisted by a calibrated instrument, to see how much torsion is needed to maintain the same angular position against the force caused by the wave. This information can then be used to calculate the air particle movement in the wave by measuring the torsion on the disk when it is held in a steady stream of air that is moving at carefully controlled velocity.

AUDIO RESPONSE CURVES

Calibrating a Microphone

From the measured properties of air, the pressure fluctuations in a wave can be calculated, once the particle movement is known. This makes it possible to "calibrate" a microphone of any reliable type by placing it in this known sound field and measuring its electrical output with suitable instruments.

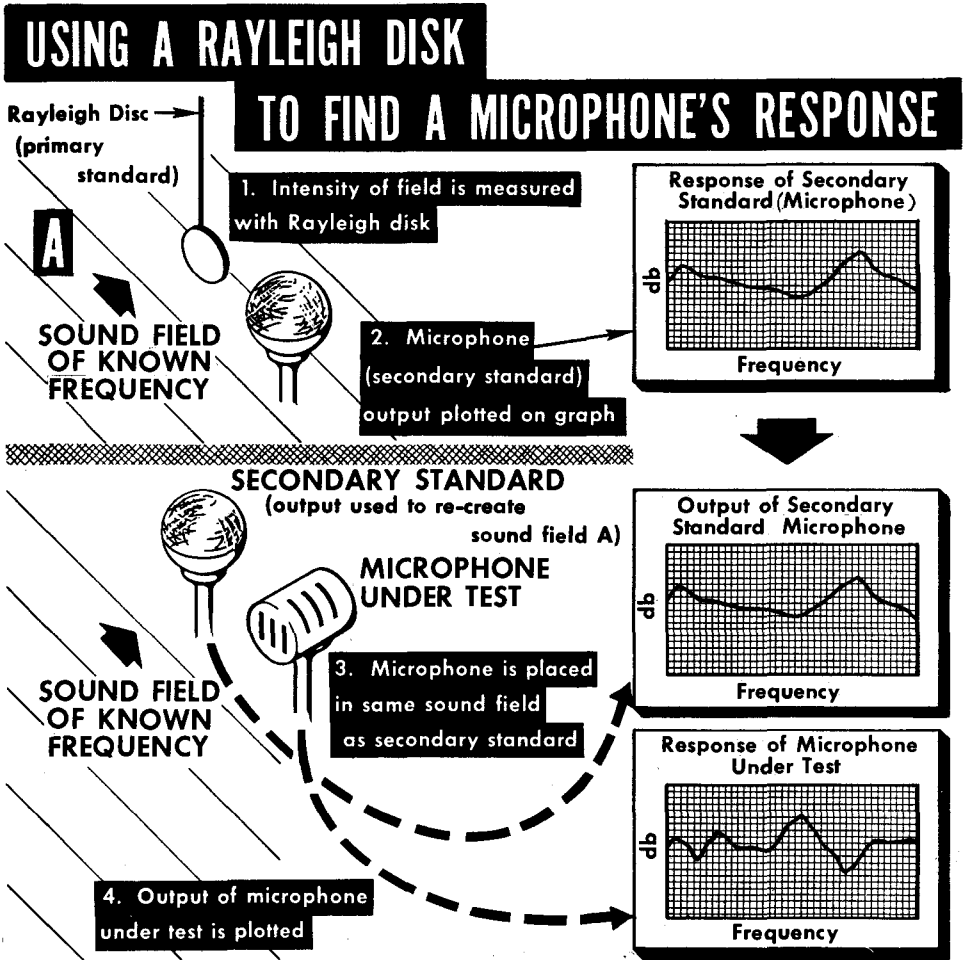

In this way we get a calibrated microphone—one with which we can measure a sound field, by making measurements and referring to its calibration chart. From this we can measure the performance of any other item of audio equipment. This calibrated microphone is called a "secondary-standard." Another microphone in the same sound field can be compared against the secondary standard, and an *absolute* response obtained for it by using the secondary standard's calibration chart.

AUDIO RESPONSE CURVES

Microphone and Speaker Response Curves

Determining The Response Of A Loudspeaker

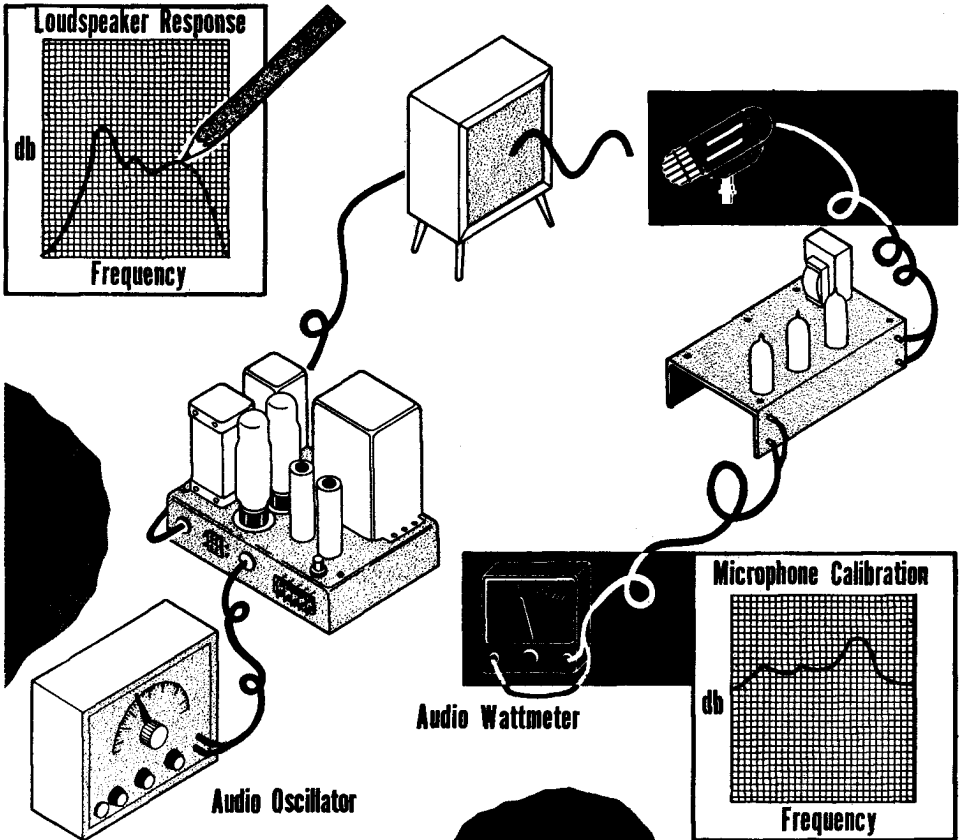

The response of a loudspeaker can also be found by using a calibrated microphone to measure the sound field that it radiates at different frequencies. For all these purposes, it is obvious that the calibrated, or secondary standard microphone should be as near perfect in response as possible, so that little correction will be necessary from its chart. High-quality condenser microphones and a special form of crystal microphone without any lever system, are favored for this purpose.

All this kind of work is very informative in finding out how good equipment *is*, but we are left with the question of how good it *should be*. To know this, we want to know something about people's hearing faculties. After all, the main purpose of audio equipment is to produce a satisfactory listening illusion.

AUDIO RESPONSE CURVES

Calibrated Amplifier

But how do you measure the output from a microphone, when this is only a few microvolts. Most voltmeters will not read anything smaller than a few volts. The voltage from the microphone needs amplification. This means we need an amplifier whose amplification is accurately known.

Such an amplifier is called a *calibrated amplifier*. To calibrate an amplifier we need to apply very carefully measured input voltages and then measure the output voltages. To get the known input voltage, this must be big enough to measure directly, so a voltage about the same as the amplifier output is used. Then it is passed through a resistance divider arrangement called an *attenuator*. The values of these resistors are accurately measured, so that the voltage applied to the amplifier input will be a very accurate fraction of the larger input voltage.

Calibrating an Amplifier

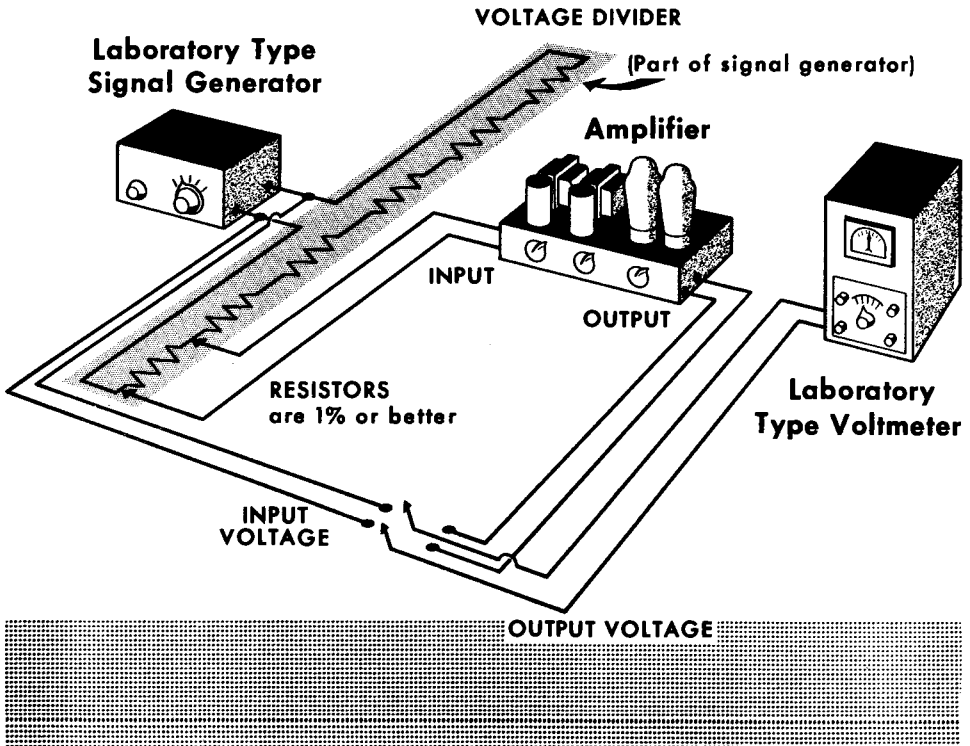

AUDIO RESPONSE CURVES

The Ear's Response Curve

To make these basic hearing tests, a number of people were used as subjects. Each person was asked to tell when tones of different frequency sounded equally loud. Using a frequency of 1000 cycles as a reference, the response of individual ears could be plotted in this way for different volume levels. When this was done, an average was taken for a large number of people, and the resulting curves are shown here. These curves are not a close representation of the response of your ears, nor indeed of any one person's. Careful analysis of the results showed that hardly anyone has an "average" pair of ears. Individual hearing may differ widely (by 10 decibels or more) from the average response.

EQUAL-LOUDNESS CURVES

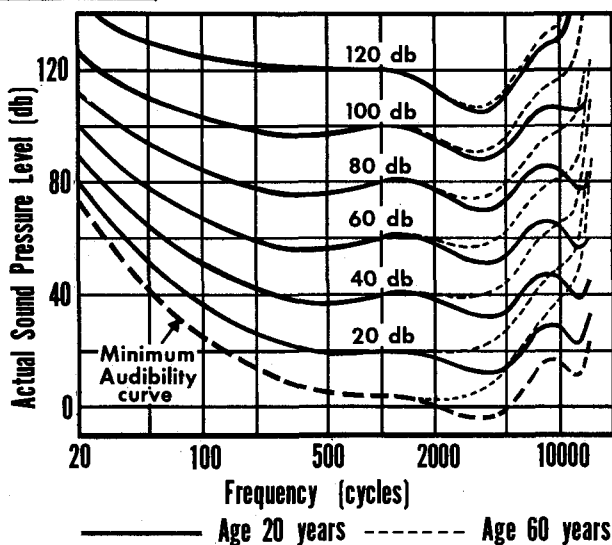

This fact shows us that "taste" in music or quality is not solely responsible for differences in opinion about audio equipment—individual people's ears give different impressions for them to judge by. Added to this difference is the fact that we do not hear a musical program as a number of groups of frequencies. In the composite of frequencies presented, our ears have the ability to recognize individual instruments in an orchestra (if the reproduction is good) even though the frequencies each instrument uses overlap.

These facts can readily be recognized by anyone with a little listening experience. They are mentioned here to complete the picture of what comprises "Audio." The explanation must come later, and will appear in one of the later volumes in this course.

QUESTIONS AND PROBLEMS

1. What are the natural limitations to obtaining a voice coil of specific resistance? If a voice coil, wound in 4 layers, has a resistance of 10 ohms, what would be the approximate resistance of a coil of the same dimensions, wound of a wire whose gauge would permit 5 layers?
2. What is matching (a) as applied to microphones, (b) as applied to loudspeakers? If a loudspeaker has a voice-coil resistance of 8 ohms and an amplifier output needs a load of 5000 ohms, what transformer turns ratio is needed?
3. If the voice-coil resistance in Question 2 were 10 ohms instead of 8 ohms, what load would be provided for the amplifier by the same transformer?
4. What led to the use of multiple loudspeaker units to cover the audio range?
5. Why are dividing networks used with multiple loudspeaker systems? What might result from failure to use a suitable network?
6. Networks consisting of resistance and capacitance or resistance and inductance produce division of voltage or current according to frequency. Why cannot networks of these types be used to feed power to loudspeakers?
7. What is basic difference between networks in which the elements are (a) in series, (b) in parallel?
8. In the simplest type crossover, suppose the crossover frequency is 800 cycles. How much of the total amplifier power of 10 watts goes to each unit, when the frequency is (a) 400 cycles, (b) 800 cycles, (c) 1600 cycles?
9. What is the effect of using more inductors and capacitors in crossover networks? Explain how this difference in response is achieved.
10. What is meant by phasing? How would you tell if two loudspeaker units were connected to provide correct phasing?
11. What is resonance? State in which of the following it is a desirable feature, and in which it is undesirable: piano, microphone, violin, marimba, loudspeaker, organ pipe, flute, oboe, phonograph pickup.
12. A moving-iron loudspeaker, when compared with a moving-coil type, actually seemed louder, although its quality was poor, particularly in the bass. Explain this with reference to the effect of resonance.
13. Explain how a simple device can be used to obtain calibration of the particle velocity of air in sound wave. Does a Rayleigh disk discriminate between waves from the back or front? Is it uniformly sensitive to sound waves from all directions?
14. Is human hearing uniformly sensitive to all audible frequencies, and does its sensitivity to different frequencies depend on their intensity?

INDEX TO VOL. 1

- Absolute standard, 1-105
Absorption, 1-29
Accordion, sound of, 1-7
Acoustic:
 amplifiers, 1-44
 lens, 1-81
 power, 1-12, 60
 slit, 1-80
Air, barometric pressure
 of, 1-5
 compression of, 1-2, 70
 density of, 1-5
 elasticity of, 1-5
 expansion in, 1-7
 modulated pressure in,
 1-45
 movement, 1-2, 23, 50, 67
 73, 106
 rarefaction in, 1-7, 24
 sound in, 1-6
 temperature of, 1-5
Amplifier, acoustic, 1-44
 electric, 1-45
 electronic, 1-45
 pneumatic, 1-45
Amplifier, calibrated, 1-109
Amplitude of vibration, 1-19
Anechoic room, 1-43
Audibility, range of, 1-13
Audio measurements, 1-106
Background, 1-43
Baffle, bass reflex, 1-70
 infinite, 1-69
 loudspeaker, 1-68
 phase in, 1-71
Barometric pressure of air,
 1-5
Bass-reflex baffle, 1-70
Bells, sound from, 1-21
Bidirectional microphone,
 1-56
Brick, sound in, 1-6
Build-up of sound, 1-28
Calibration of microphones,
 1-107
Capacitor (in crossovers),
 1-94-100
Carbon microphone, 1-55
Cardioid microphone, 1-57
Centering spider, 1-49
Closed pipe, 1-22
Coil (*see* Inductor
 and Voice coil)
Compressibility of air, 1-5
Compression of air, 1-2, 70
Computers, 1-1
Condenser microphone, 1-51
Cone, loudspeaker, 1-65
Crossover, parallel-fed, 1-97
 series-fed, 1-98
 three-element, 1-101
 two-element, 1-99
Crystal loudspeaker, 1-84
Crystal microphone, 1-53
Current-dividing network,
 1-96
Cutter, phonograph, 1-105
Decay of sound, 1-31
Decibel, 1-15
Density of air, 1-5
Diaphragm, loading of, 1-69
 loudspeaker, 1-65, 83
 microphone, 1-47, 51, 54,
 55
Directivity, horn, 1-79
 microphone, 1-56
Dividing networks, 1-96
 current, 1-93
 voltage, 1-94
Drums, sound of, 1-21, 104
Dynamic microphone, 1-48
Ear, response curves of,
 1-110
 trumpet, 1-44
Echo, 1-26
Efficiency, loudspeaker, 1-72
Elasticity of air, 1-5
Electrical pickup, 1-19
Electronic amplifier, 1-45
Electrostatic loudspeaker,
 1-82
 microphone, 1-51
Enclosures, loudspeaker,
 1-68-79
Expansion of air, 1-7
 of wave, 1-32, 74
Exponential horn, 1-75
Fechner's Law, 1-15
Folded horn, 1-77
Frequency, 1-8
 fundamental, 1-18
 harmonic, 1-18
 logarithmic scale, 1-9
 low and high, 1-40
 instruments, 1-37
 range of musical
 wavelength and, 1-39, 66
Fundamental frequency,
 1-18
Gradient, pressure, 1-50, 56
Guitar, sound of, 1-19
Harmonica, sound of, 1-7
Harmonics, 1-18
Headphones, 1-1
Hearing, threshold of, 1-13
High fidelity, 1-34
High-frequency radiation,
 1-40
Horn:
 directivity, 1-79
 exponential, 1-75
 folded, 1-77
 loudspeaker, 1-72
 mouth size, 1-75
 re-entrant, 1-78
 shapes, 1-74
 throat, 1-74
 tractrix, 1-79
Impact, 1-4, 42
Impedance,
 microphone, 1-61
Impedance ratio, 1-92
Inductor (in crossovers),
 1-95-100
Infinite baffle, 1-69
Intensity, 1-11
Intercommunication sets,
 1-59
Inverse-square law, 1-32
Ionophone, 1-85
Iron, sound in, 1-6
Lens, acoustic, 1-81
Level difference, minimum
 perceptible, 1-15
Loading, diaphragm, 1-69
Logarithmic:
 frequency scale, 1-9
 loudness scale, 1-15
 volume control, 1-17
Loudness, 1-11
 scale of, 1-15
Loudspeaker:
 baffle, 1-68-79
 cone, 1-65
 crossovers, 1-93
 crystal, 1-84
 diaphragm, 1-65, 1-83
 efficiency, 1-72
 electrostatic, 1-82

INDEX

- enclosure, 1-68 – 79
 - folded-horn, 1-77
 - horn, 1-72 – 79
 - infinite, 1-69
 - matching, 1-88
 - moving-coil, 1-65
 - moving-iron, 1-64
 - need for, 1-63
 - phasing, 1-71, 102
 - radiation, 1-38
 - response curves, 1-108
- Low-frequency radiation, 1-40
- Magnetic structure, 1-48, 64, 65
- Marimba, sound of, 1-103
- Masking, 1-15, 34
- Matching, loudspeaker, 1-88
 - microphone, 1-60
 - need for, 1-87
 - transformer, 1-60, 89
- Measurements, audio, 1-105
 - vibration, 1-1
- Megaphone, 1-33, 44, 71
- Microphone, bidirectional, 1-56
 - calibrating, 1-107
 - carbon, 1-55
 - cardioid, 1-57
 - condenser, 1-51
 - crystal, 1-53
 - diaphragm, 1-47, 51, 54, 55
 - directivity, 1-56
 - dynamic, 1-48
 - electrostatic, 1-51
 - matching, 1-60
 - moving-coil, 1-48
 - need for, 1-47
 - omnidirectional, 1-56
 - piezoelectric, 1-53
 - pressure, 1-56
 - pressure-gradient, 1-50, 56
 - response curve, 1-108
 - ribbon, 1-50, 56, 60
 - sensitivity, 1-58
 - unidirectional, 1-57
 - velocity, 1-50
- Modulated air pressure, 1-45
- Movement of air, 1-2, 23, 50, 67, 73, 106
- Moving-coil loudspeaker, 1-65
- Moving-coil microphone, 1-48
- Moving-iron loudspeaker, 1-64
- Musical instruments, frequency range of, 1-37
- Noise, 1-7, 36
- Octave, 1-9
- Omnidirectional microphone, 1-56
- Open pipe, 1-24
- Organ, sound of, 1-21, 39
- Overtones, 1-18
- Parallel-fed networks, 1-96, 97
- Particle velocity, 1-3, 23, 58, 70
- Perceptible level difference, 1-15
- Periodic vibrations, 1-7
- Phase, 1-71, 102
- Phonograph, 1-1
 - cutter, 1-105
 - pickup, 1-103
- Piano, sound of, 1-7
- Pickup, electrical, 1-19
 - microphone, 1-56
 - phonograph, 1-103
- Piezoelectric loudspeaker, 1-84
 - microphone, 1-53
- Pipe, closed, 1-22
 - open, 1-24
- Pipes, sound of, 1-21, 103
- Pitch, 2-8
- Pneumatic amplifier, 1-45
- Polarizing carbon microphone, 1-55
 - condenser microphone, 1-52
- Port, 1-71
- Power, acoustical, 1-12, 60
 - from microphones, 1-60
 - to loudspeakers, 1-89
- Pressure, barometric, 1-5
 - microphone, 1-50, 56
 - sound, 1-23, 58, 70
- Pressure-gradient microphone, 1-50, 56
- Propagation velocity, sound, 1-3
- Quality of sound, 1-18
- Radiation, loudspeaker, 1-38
 - low- and high-frequency, 1-40
- Radio, 1-1
- Range of audibility, 1-13
- Rarefaction of air, 1-7 – 24
- Ratio, impedance, 1-92
 - turns, 1-90
- Rayleigh disk, 1-106
- Receiver, radio, 1-1
 - telephone, 1-58
- Recording, 1-1
- Reeds, sound of, 1-21, 103
- Re-entrant horn, 1-78
- Reflection of sound, 1-27
- Reflex enclosure, 1-70
- Reinforcement by reverberation, 1-36
- Reproduction, audio, 1-1
- Resonance, 1-103
- Response curve, human ear, 1-110
 - loudspeaker, 1-108
 - microphone, 1-108
- Reverberation, 1-41
 - reinforcement by, 1-36
 - time, 1-31
- Ribbon microphone, 1-50, 56, 60
- Ripple tank, 1-28
- Secondary standard, 1-107
- Sensitivity, microphone, 1-58
- Series-fed networks, 1-94, 98
- Shadow effects, 1-40
- Shock wave, 1-2
- Slit, acoustic, 1-80
- Sonar, 1-1
- Soundboard of piano, 1-7
- Sound, build-up of, 1-31
 - decay of, 1-31
 - direction of, 1-38
 - effect of wind on, 1-35
 - field, 1-105
 - in various materials, 1-6
 - of bars, 1-21
 - of bells, 1-21
 - of musical instruments, 1-7, 19, 21, 23, 38, 103
 - pressure, 1-23, 58, 70
 - quality, 1-18
 - reflection of, 1-28
 - speech, 1-42
 - speed of, 1-3
 - waves, 1-3
- Speaking tube, 1-72
- Speech sounds, 1-42
- Speed of sound, 1-3
- Spider, centering, 1-49

INDEX

- Standard, absolute, 1-105
 - secondary, 1-107
- Standing waves, 1-24, 28
 - 105
- Steel, sound in, 1-6
- Supersonic flight, 1-2
- Super tweeter, 1-93
- Suspension, 1-49

- Telephone, 1-55, 58, 104
- Temperature, effect of, 2-5
- Three-element crossover, 1-101
- Timbre, 1-18, 103
- Time, reverberation, 1-31
- Tone, continuous, 1-30
 - interval, 1-9
- Tractrix horn, 1-79

- Transducer, 1-47
- Transformer, matching, 1-60, 89
- Transients, 1-41
- Transmitter, radio, 1-1
 - telephone, 1-55, 58, 104
- Triangle, sound of, 1-21
- Trumpet, ear, 1-44
 - sound of, 1-38
- Turns ratio, 1-90
- Tweeters, 1-67, 93
- Two-element crossover, 1-99
- Unidirectional microphone, 1-57
- Velocity microphone, 1-50
- Velocity particle, 1-3, 23, 58, 70

- propagation, 1-3
- Vibration, amplitude of, 1-19
 - measurement, 1-1
 - periodic 1-7
- Violin, sound of, 1-7
- Voice coil, 1-49, 65, 69
- Volume control, 1-17

- Water, sound in, 1-6
- Wave expansion, 1-32, 74
- Wavelength and frequency, 1-39, 66
- Waves, sound, 1-3
 - standing, 1-3
- Wind instruments, sound of, 1-7
- Xylophone, sound of, 1-103